

## Features

- CRM(CQ) Super\_Junction technology
- Much lower Ron\*A performance for On-state efficiency
- Much lower FOM for fast switching efficiency

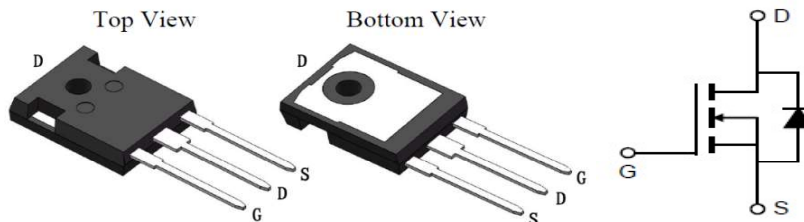
## Applications

- LED/LCD/PDP TV and monitor Lighting
- Solar/Renewable/UPS-Micro Inverter System
- Charger
- Power Supply

## Product Summary

VDS	650V
R <sub>DS(on)_typ</sub>	77mΩ
I <sub>D</sub>	43A

**100% Avalanche Tested**



## Package Marking and Ordering Information

Part #	Marking	Package	Packing	Reel Size	Tape Width	Qty
CRJQ80N65F	-	TO-247	Tube	N/A	N/A	30pcs

## Absolute Maximum Ratings

Parameter	Symbol	Value	Unit
Drain-source voltage	V <sub>DS</sub>	650	V
Continuous drain current T <sub>C</sub> = 25°C T <sub>C</sub> = 100°C	I <sub>D</sub>	43 33.7	A
Pulsed drain current (T <sub>C</sub> = 25°C, t <sub>p</sub> limited by T <sub>jmax</sub> )	I <sub>D pulse</sub>	172	A
Avalanche energy, single pulse (L=60mH, R <sub>g</sub> =30Ω)	E <sub>AS</sub>	750	mJ
Gate-Source voltage	V <sub>GS</sub>	±30	V
Power dissipation (T <sub>C</sub> = 25°C)	P <sub>tot</sub>	470	W
Operating junction and storage temperature	T <sub>j</sub> , T <sub>stg</sub>	-55...+150	°C

**Thermal Resistance**

Parameter	Symbol	Value	Unit
Thermal resistance, junction – case. Max	$R_{thJC}$	0.27	°C/W
Thermal resistance, junction – ambient. Max	$R_{thJA}$	41	

**Electrical Characteristic (at  $T_j = 25\text{ }^\circ\text{C}$ , unless otherwise specified)**

Parameter	Symbol	Value			Unit	Test Condition
		min.	typ.	max.		

**Static Characteristic**

Drain-source breakdown voltage	$BV_{DSS}$	650	-	-	V	$V_{GS}=0V, I_D=250\mu A$
Gate threshold voltage	$V_{GS(th)}$	3.5	-	4.5	V	$V_{DS}=V_{GS}, I_D=250\mu A$
Zero gate voltage drain current	$I_{DSS}$	-	-	5	$\mu A$	$V_{DS}=650V, V_{GS}=0V$ $T_C=25^\circ C$ $T_C=150^\circ C$
Gate-source leakage current	$I_{GSS}$	-	0.3	80	nA	$V_{GS}=\pm 30V, V_{DS}=0V$
Drain-source on-state resistance	$R_{DS(on)}$	-	77	90	mΩ	$V_{GS}=10V, I_D=21.5A,$ $T_C=25^\circ C$ $T_C=150^\circ C$
Transconductance	$g_{fs}$	-	30	-	S	$V_{DS}=20V, I_D=21.5A$

**Dynamic Characteristic**

Input Capacitance	$C_{iss}$	-	3435	-	pF	$V_{GS}=0V, V_{DS}=100V,$ $f=1MHz$
Output Capacitance	$C_{oss}$	-	137	-		
Reverse Transfer Capacitance	$C_{rss}$	-	27	-		
Gate Total Charge	$Q_G$	-	84	-	nC	$V_{GS}=10V, V_{DS}=480V,$ $I_D=21.5A, f=1MHz$
Gate-Source charge	$Q_{gs}$	-	28	-		
Gate-Drain charge	$Q_{gd}$	-	36	-		
Turn-on delay time	$t_{d(on)}$	-	89	-	ns	$T_j=25^\circ C, V_{GS}=10V,$ $I_D=21.5A, V_{DS}=400V,$ $R_g=27\Omega$
Rise time	$t_r$	-	131	-		
Turn-off delay time	$t_{d(off)}$	-	204	-		
Fall time	$t_f$	-	69	-		
Gate resistance	$R_G$	-	0.8	-	Ω	$V_{GS}=0V, V_{DS}=0V, f=1MHz$

**Body Diode Characteristic**

Parameter	Symbol	Value			Unit	Test Condition
		min.	typ.	max.		
Body Diode Forward Voltage	$V_{SD}$	0.7	0.92	1.2	V	$V_{GS}=0V, I_{SD}=21.5A$
Body Diode Reverse Recovery Time	$t_{rr}$	-	113	-	ns	$I_{sd}=21.5A$ $dI/dt=100A/us, V_{ds}=100V$
Body Diode Reverse Recovery Charge	$Q_{rr}$	-	0.61	-	uC	

## Typical Performance Characteristics

Fig 1. Output Characteristics (Tj=25°C)

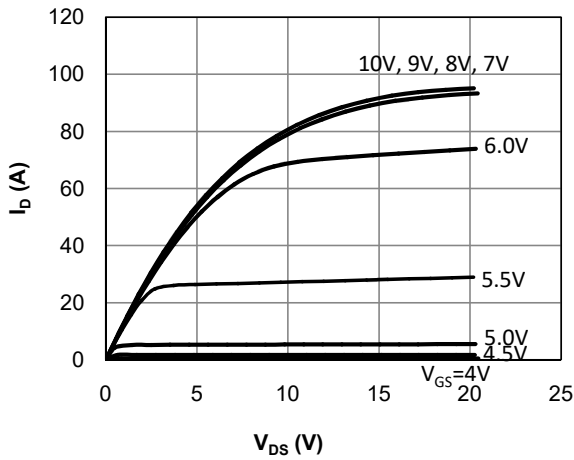


Fig 2. Output Characteristics (Tj=150°C)

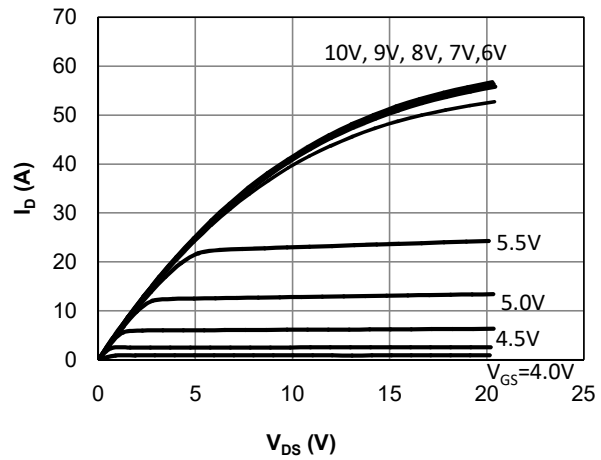


Fig 3: Transfer Characteristics

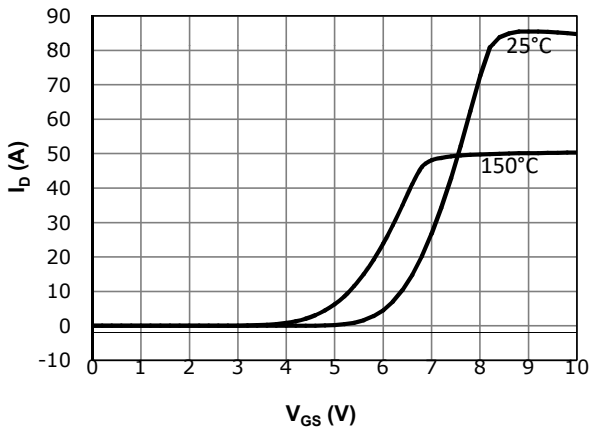


Fig 4: V<sub>TH</sub> Vs Tj Temperature Characteristics

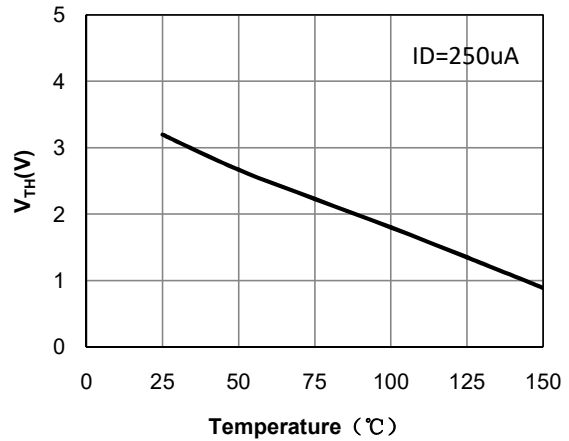


Fig 5: R<sub>DS(on)</sub> Vs Ids Characteristics(Tc=25°C)

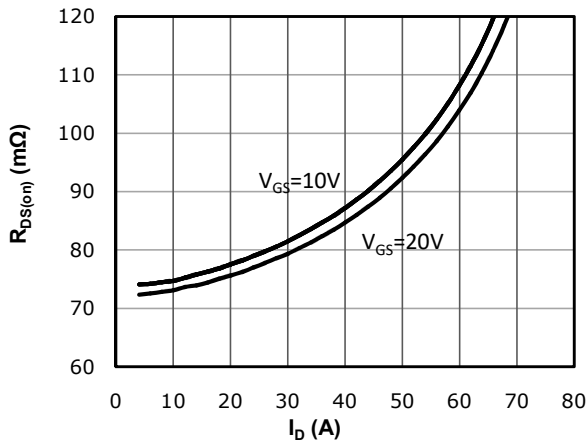
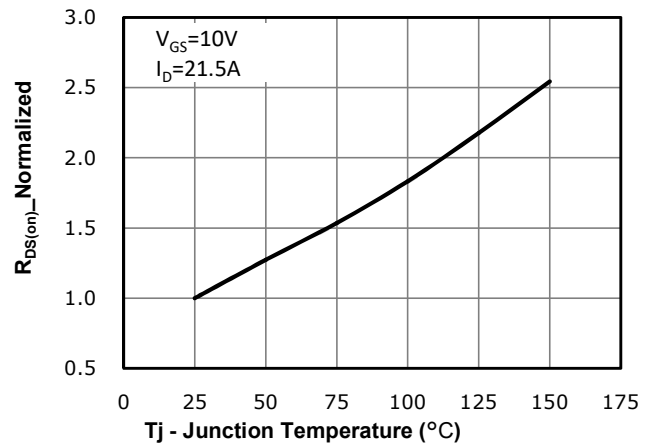
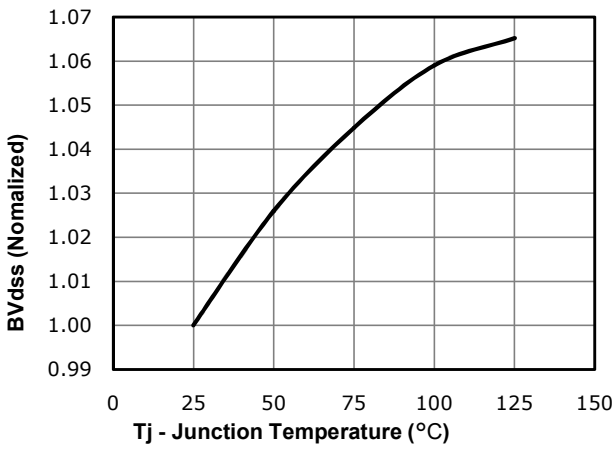


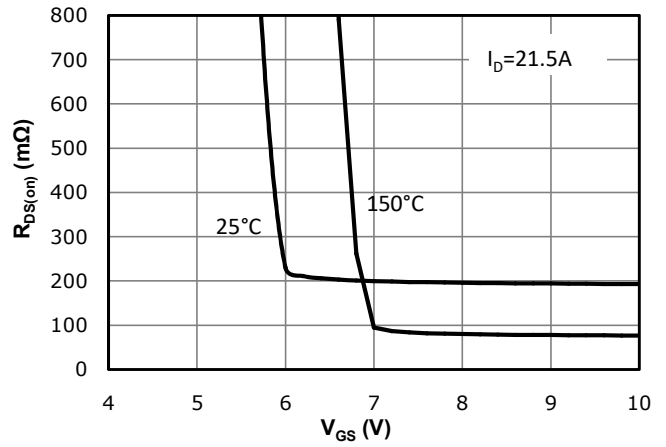
Fig 6: R<sub>DS(on)</sub> vs. Temperature



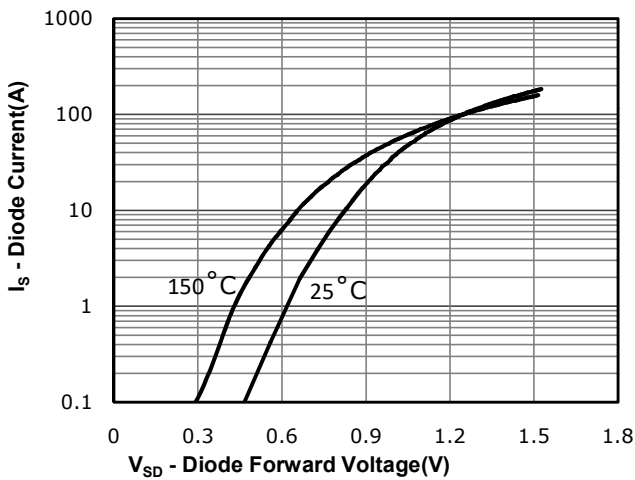
**Fig 7: BVDSS vs. Temperature**



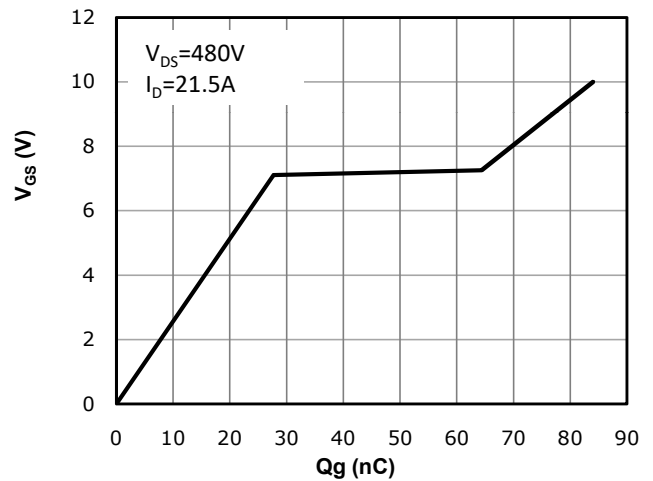
**Fig 8: Rds(on) vs Gate Voltage**



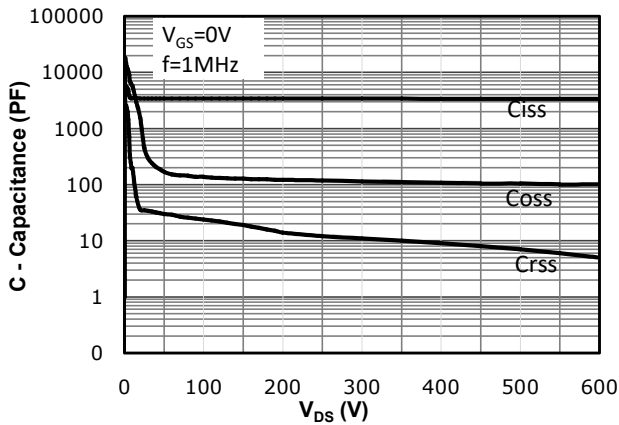
**Fig 9: Body-diode Forward Characteristics**



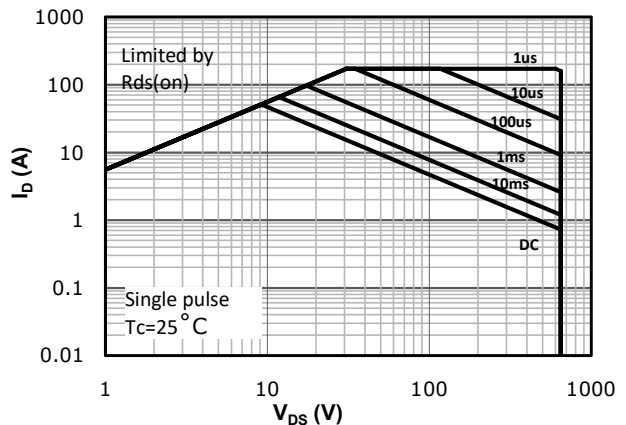
**Fig 10: Gate Charge Characteristics**



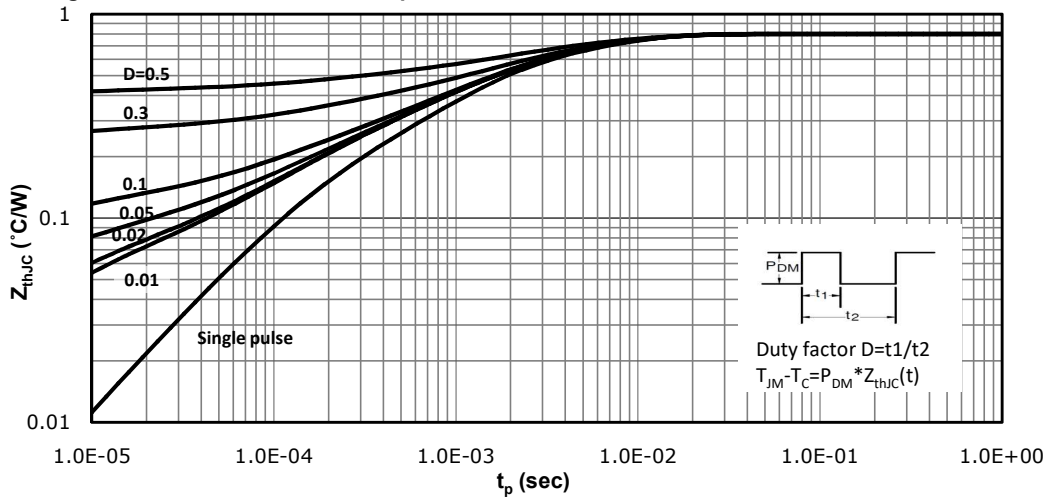
**Fig 11: Capacitance Characteristics**



**Fig 12: Safe Operating Area**

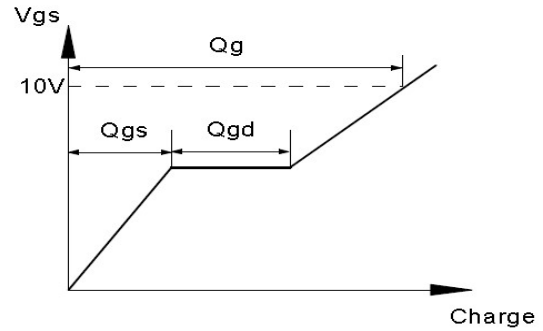
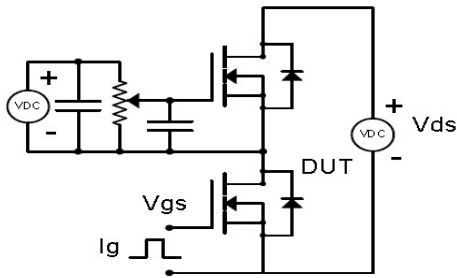


**Fig 13: Max. Transient Thermal Impedance**

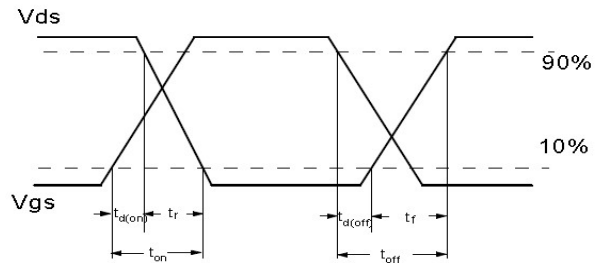
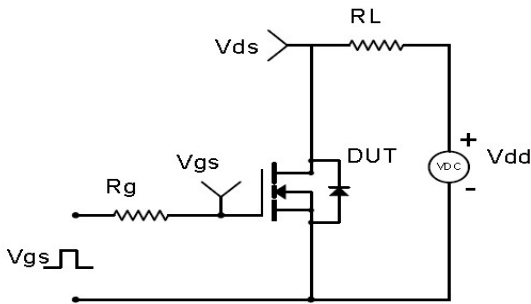


## Test Circuit & Waveform

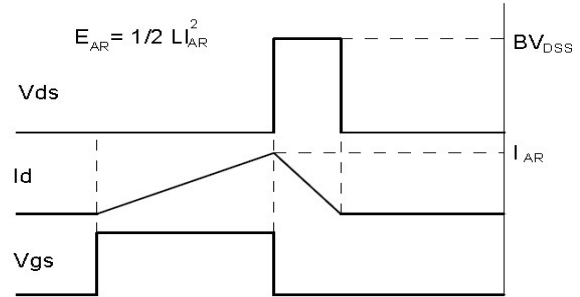
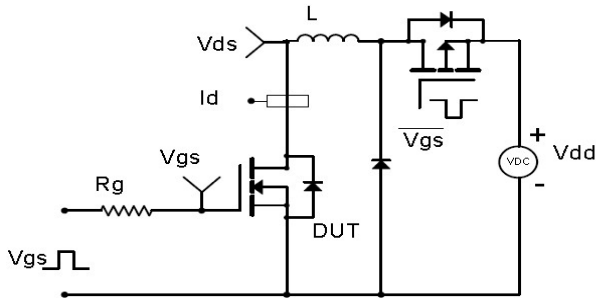
Gate Charge Test Circuit & Waveform



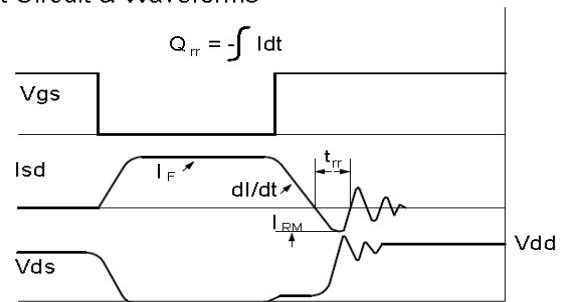
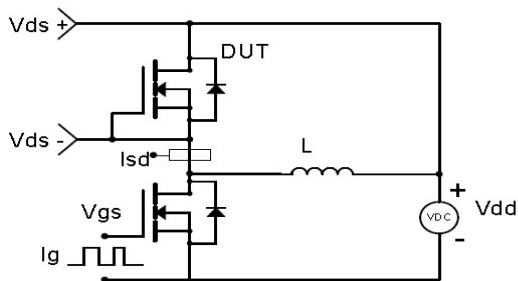
Resistive Switching Test Circuit & Waveforms



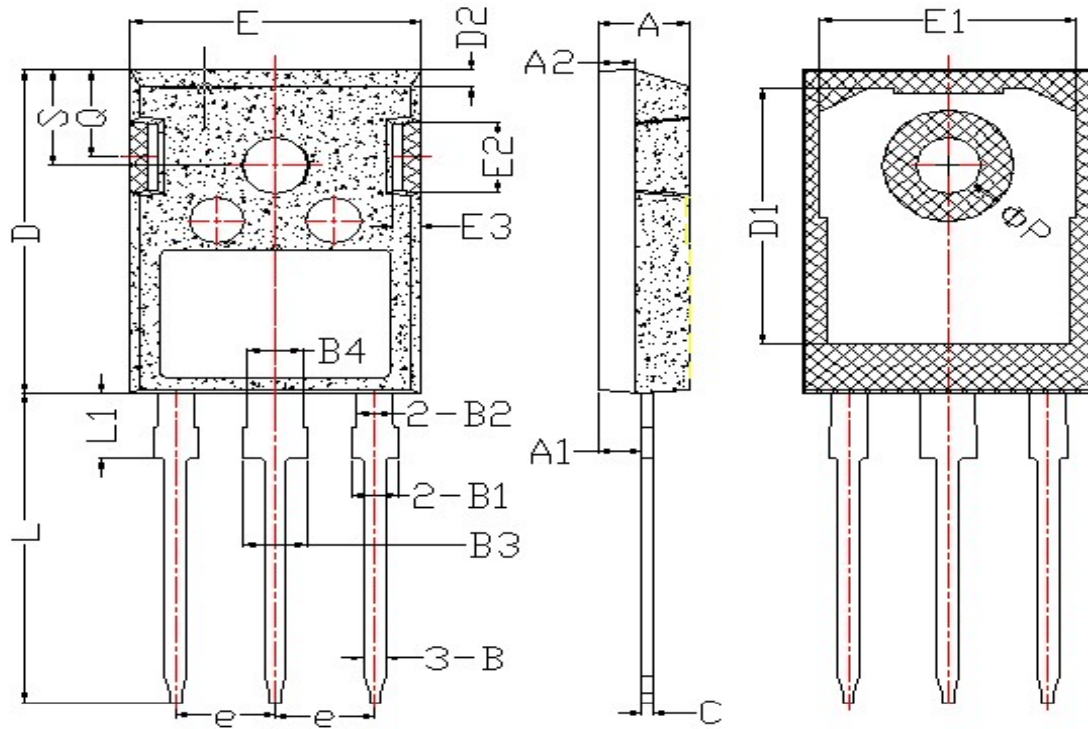
Unclamped Inductive Switching (UIS) Test Circuit & Waveforms



Diode Recovery Test Circuit & Waveforms



## Package Outline: TO-247



Symbol	Dimensions In Millimeters		Dimensions In Inches	
	Min.	Max.	Min.	Max.
A	4.60	5.20	0.181	0.205
A1	2.20	2.60	0.087	0.102
A2	1.80	2.20	0.071	0.087
B	0.90	1.40	0.035	0.055
B1	1.75	2.35	0.069	0.093
B2	1.75	2.15	0.069	0.085
B3	2.80	3.35	0.110	0.132
B4	2.80	3.15	0.110	0.124
C	0.50	0.70	0.020	0.028
D	20.60	21.30	0.811	0.839
D1	16.00	18.00	0.630	0.709
D2	0.90	1.40	0.035	0.055
E	15.50	16.10	0.610	0.634
E1	13.00	14.70	0.512	0.579
E2	3.80	5.30	0.150	0.209
E3	0.80	2.60	0.031	0.102
e	5.20	5.70	0.205	0.224
L	19.00	20.50	0.748	0.807
L1	3.90	4.60	0.154	0.181
ΦP	3.30	3.70	0.130	0.146
Q	5.20	6.00	0.205	0.236
S	5.80	6.60	0.228	0.260



**Revision History**

Revision	Date	Major changes
1.2	2020-7-7	Release of formal version

**Disclaimer**

Unless otherwise specified in the datasheet, the product is designed and qualified as a standard commercial product and is not intended for use in applications that require extraordinary levels of quality and reliability, such as automotive, aviation/aerospace and life-support devices or systems.

Any and all semiconductor products have certain probability to fail or malfunction, which may result in personal injury, death or property damage. Customer are solely responsible for providing adequate safe measures when design their systems.

CRM(CQ) reserves the right to improve product design, function and reliability without notice.