

Model produktu	Z-39	
Format:	A4	
Materiał:	Polystyrene (PS)	
Tolerancja:	+/- 0.1	
Skala:	1:1	
		
	KRADEX ul. Nadmiejska 32 04-205 Warszawa Tel: +48 022 613-08-88, Fax: 812-10-68 www.kradex.com.pl	

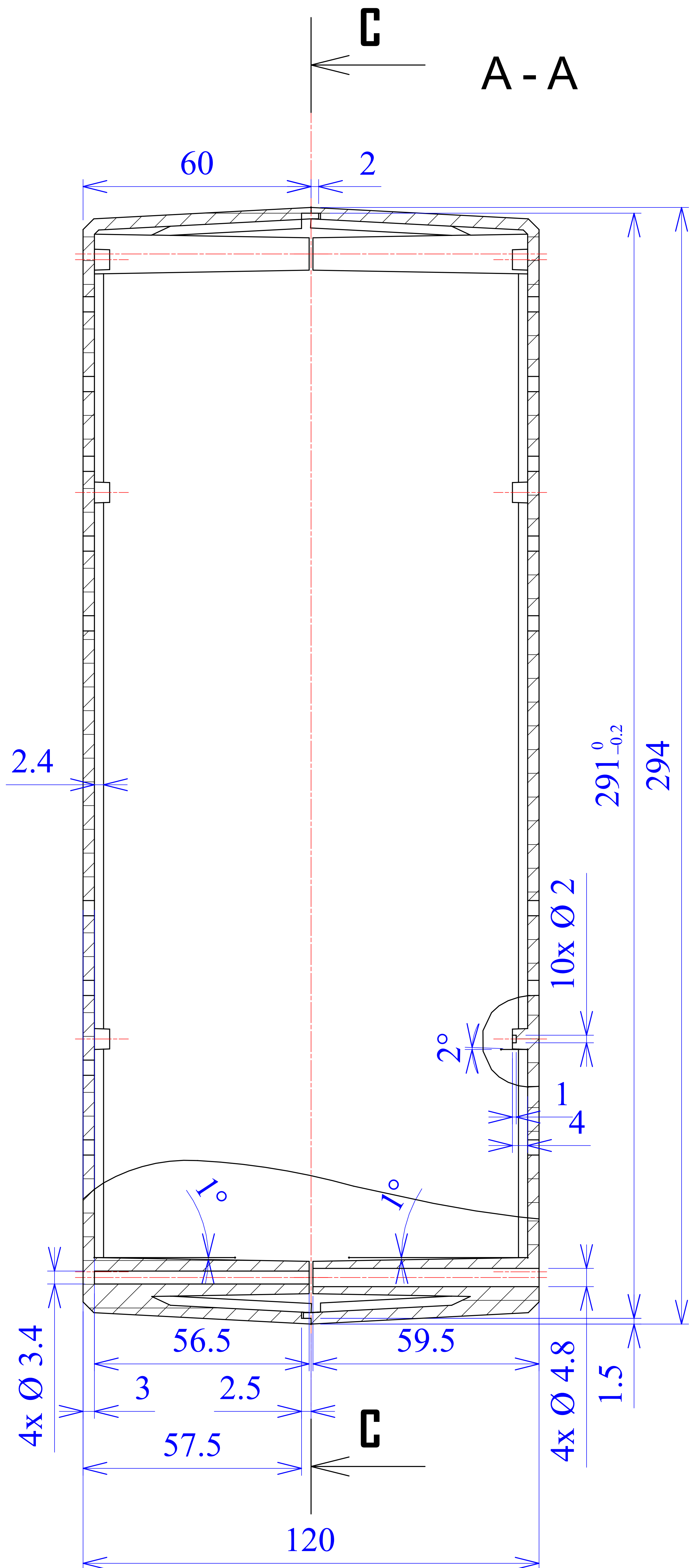

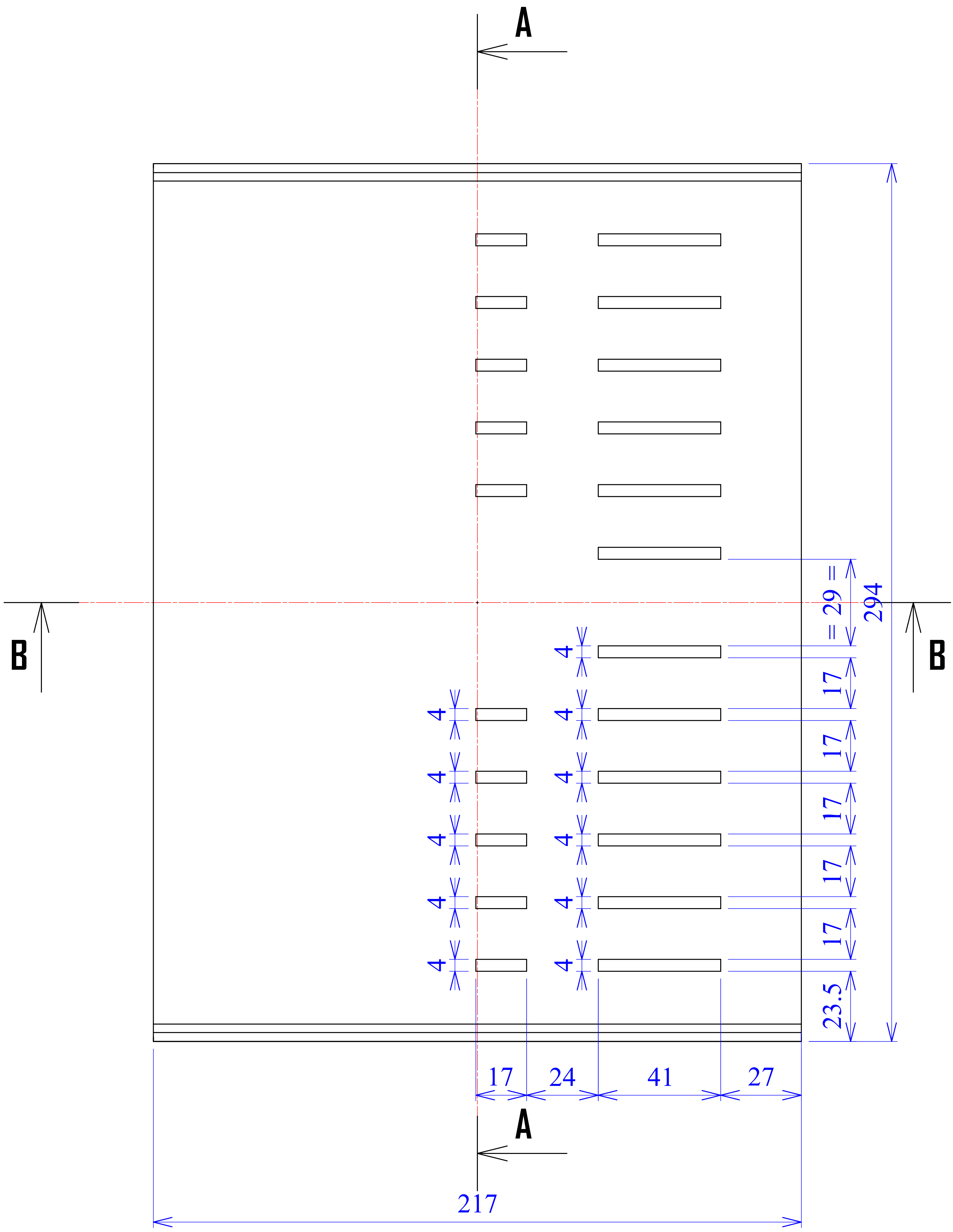

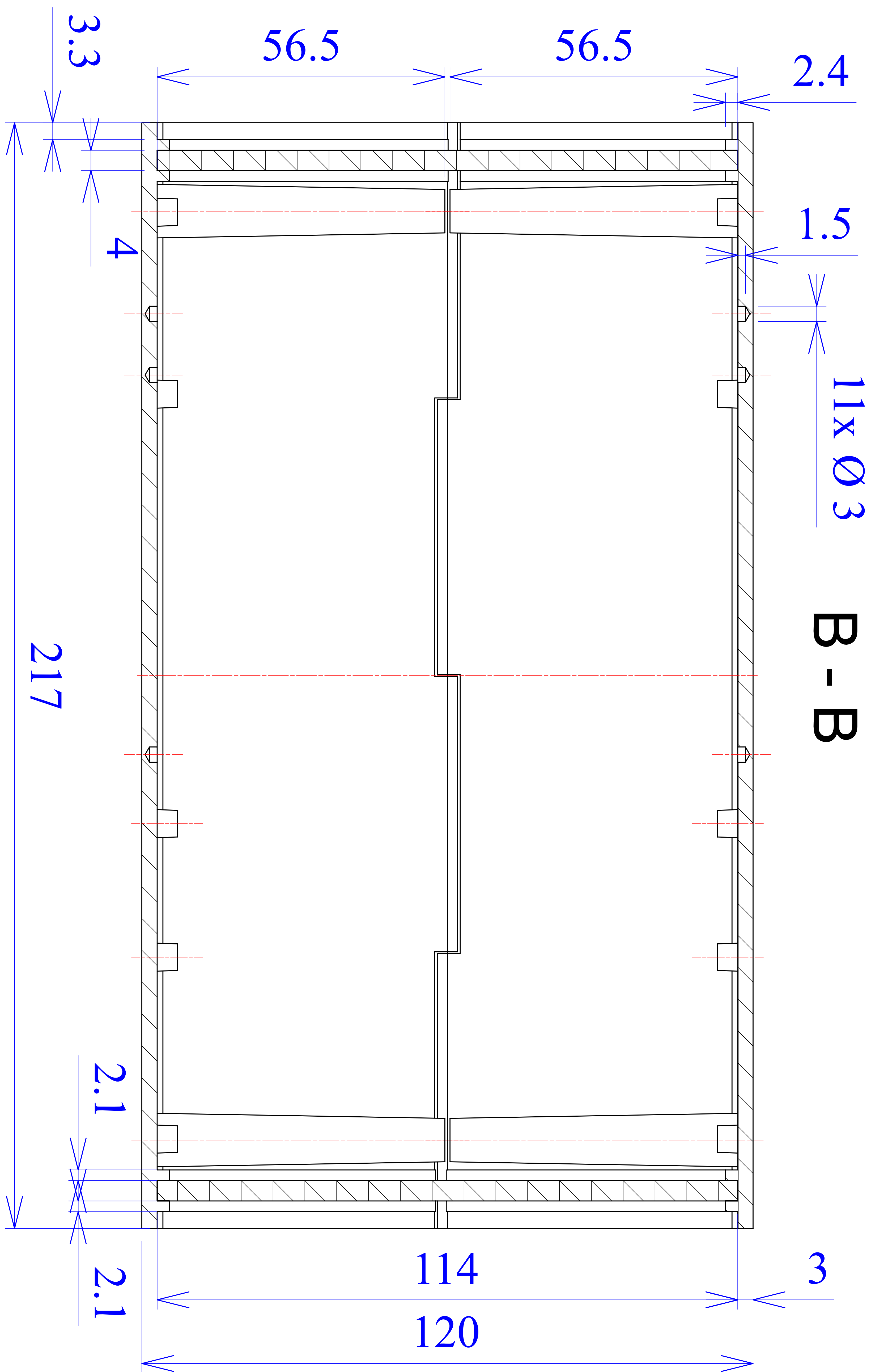

B - B

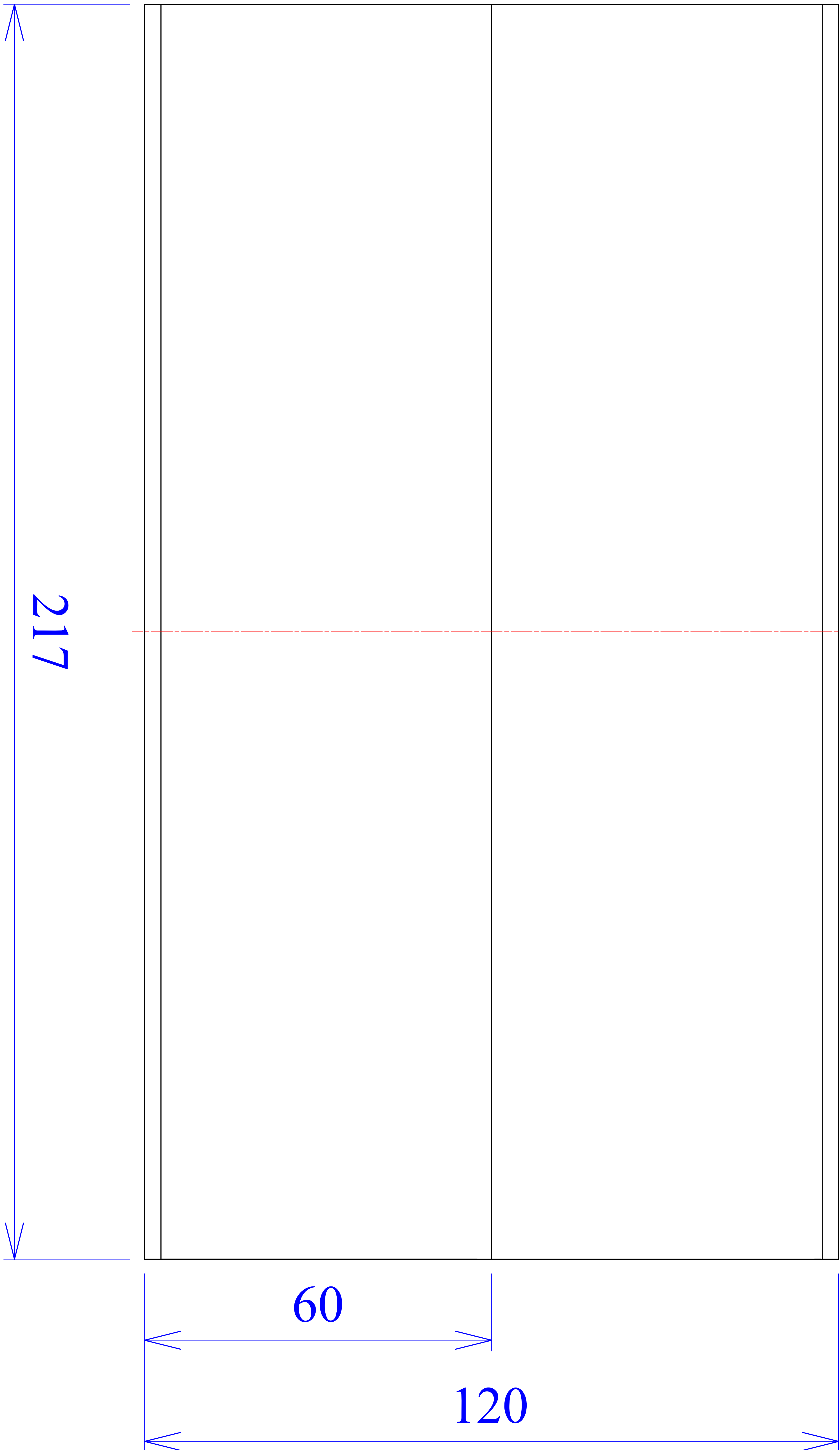

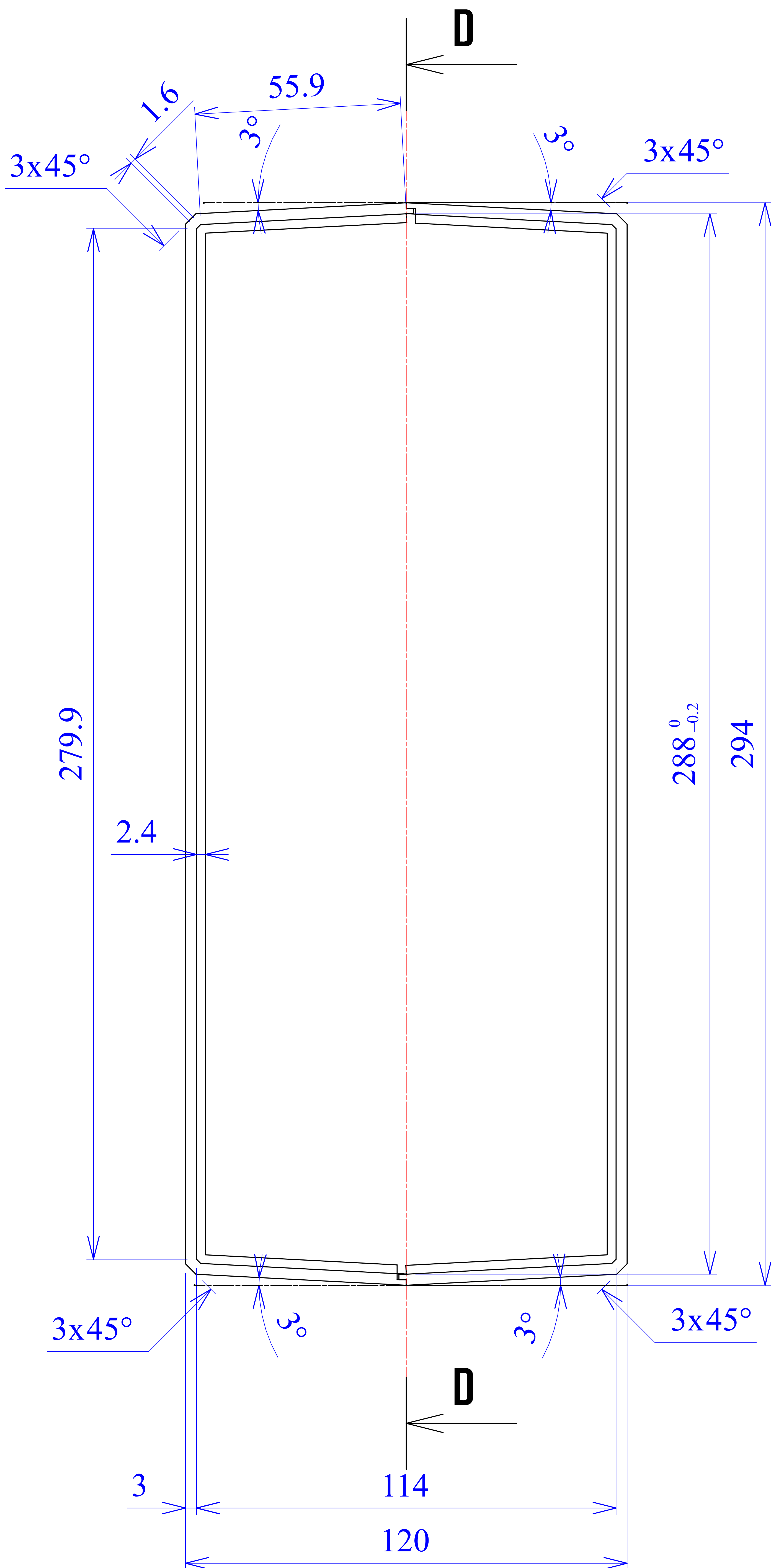

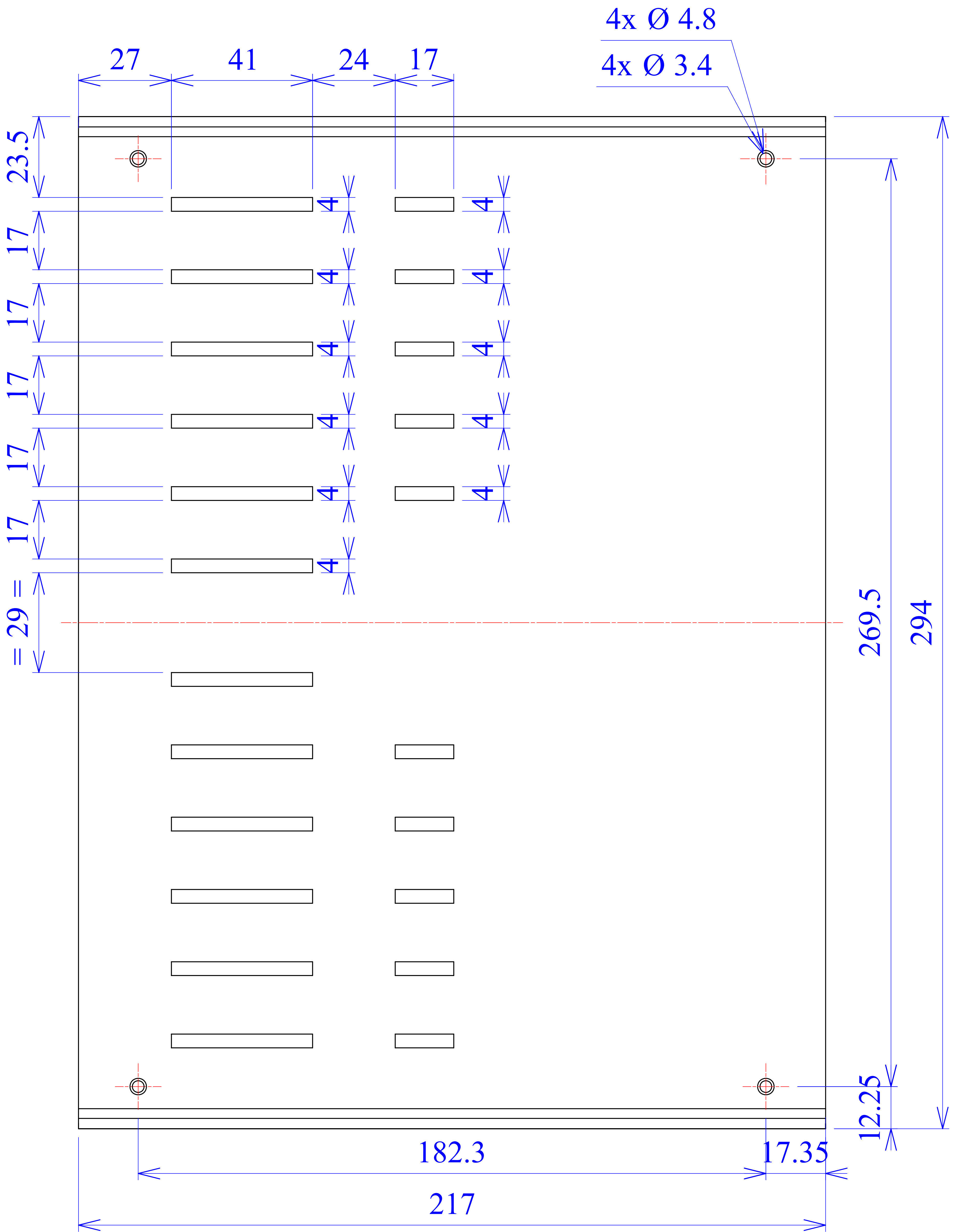

C - C

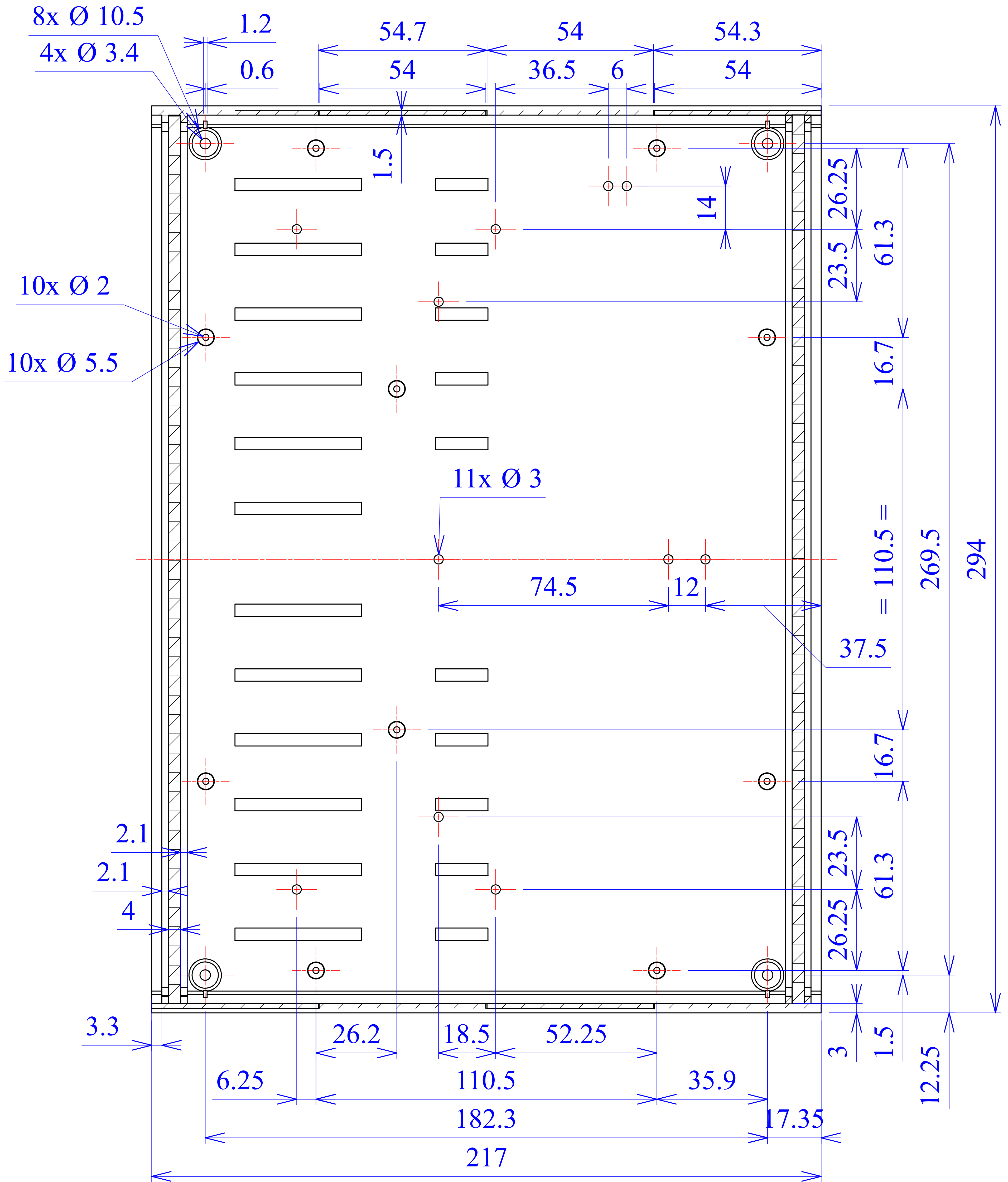

D - D

