

### FEATURES

#### Easy to use

Higher performance than discrete design

Single-supply and dual-supply operation

Rail-to-rail output swing

Input voltage range extends 150 mV below ground (single supply)

Low power, 550  $\mu$ A maximum supply current

Gain set with one external resistor

Gain range: 1 (no resistor) to 1000

High accuracy dc performance

0.10% gain accuracy ( $G = 1$ )

0.35% gain accuracy ( $G > 1$ )

10 ppm maximum gain drift ( $G = 1$ )

200  $\mu$ V maximum input offset voltage (AD623A)

2  $\mu$ V/ $^{\circ}$ C maximum input offset drift (AD623A)

100  $\mu$ V maximum input offset voltage (AD623B)

1  $\mu$ V/ $^{\circ}$ C maximum input offset drift (AD623B)

25 nA maximum input bias current

Noise: 35 nV/ $\sqrt{\text{Hz}}$  RTI noise @ 1 kHz ( $G = 1$ )

Excellent ac specifications

90 dB minimum CMRR ( $G = 10$ ); 70 dB minimum CMRR ( $G = 1$ ) at 60 Hz, 1 k $\Omega$  source imbalance

800 kHz bandwidth ( $G = 1$ )

20  $\mu$ s settling time to 0.01% ( $G = 10$ )

### APPLICATIONS

Low power medical instrumentation

Transducer interfaces

Thermocouple amplifiers

Industrial process controls

Difference amplifiers

Low power data acquisition

### GENERAL DESCRIPTION

The AD623 is an integrated single-supply instrumentation amplifier that delivers rail-to-rail output swing on a 3 V to 12 V supply. The AD623 offers superior user flexibility by allowing single gain set resistor programming and by conforming to the 8-lead industry standard pinout configuration. With no external resistor, the AD623 is configured for unity gain ( $G = 1$ ), and with an external resistor, the AD623 can be programmed for gains up to 1000.

### CONNECTION DIAGRAM



Figure 1. 8-Lead PDIP (N), SOIC (R), and MSOP (RM) Packages



Figure 2. CMR vs. Frequency, 5 V<sub>S</sub>, 0 V<sub>S</sub>

The AD623 holds errors to a minimum by providing superior ac CMRR that increases with increasing gain. Line noise, as well as line harmonics, are rejected because the CMRR remains constant up to 200 Hz. The AD623 has a wide input common-mode range and can amplify signals that have a common-mode voltage 150 mV below ground. Although the design of the AD623 was optimized to operate from a single supply, the AD623 still provides superior performance when operated from a dual voltage supply ( $\pm 2.5$  V to  $\pm 6.0$  V).

Low power consumption (1.5 mW at 3 V), wide supply voltage range, and rail-to-rail output swing make the AD623 ideal for battery-powered applications. The rail-to-rail output stage maximizes the dynamic range when operating from low supply voltages. The AD623 replaces discrete instrumentation amplifier designs and offers superior linearity, temperature stability, and reliability in a minimum of space.

#### Rev. D

Information furnished by Analog Devices is believed to be accurate and reliable. However, no responsibility is assumed by Analog Devices for its use, nor for any infringements of patents or other rights of third parties that may result from its use. Specifications subject to change without notice. No license is granted by implication or otherwise under any patent or patent rights of Analog Devices. Trademarks and registered trademarks are the property of their respective owners.

**TABLE OF CONTENTS**

|   |    |  |    |
|---|----|--|----|
| Features .....                            | 1  | Applications Information .....                                     | 16 |
| Applications.....                         | 1  | Basic Connection .....   | 16 |
| General Description .....                 | 1  | Gain Selection .....   | 16 |
| Connection Diagram .....                  | 1  | Reference Terminal .....   | 16 |
| Revision History .....                    | 2  | Input and Output Offset Voltage.....                               | 17 |
| Specifications.....                       | 3  | Input Protection .....   | 17 |
| Single Supply .....                       | 3  | RF Interference .....  | 17 |
| Dual Supplies .....                       | 4  | Grounding .....  | 18 |
| Both Dual and Single Supplies.....        | 6  | Input Differential and Common-Mode Range vs. Supply and Gain ..... | 20 |
| Absolute Maximum Ratings.....             | 7  | Outline Dimensions .....   | 22 |
| ESD Caution.....                          | 7  | Ordering Guide .....   | 23 |
| Typical Performance Characteristics ..... | 8  |  |    |
| Theory of Operation .....                 | 15 |  |    |

**REVISION HISTORY****7/08—Rev. C to Rev. D**

|   |           |
|---|-----------|
| Updated Format .....  | Universal |
| Changes to Features Section and General Description Section . | 1         |
| Changes to Table 3.....                                       | 6         |
| Changes to Figure 40.....                                     | 14        |
| Changes to Theory of Operation Section.....                   | 15        |
| Changes to Figure 42 and Figure 43.....                       | 16        |
| Changes to Table 7.....                                       | 19        |
| Updated Outline Dimensions .....                              | 22        |
| Changes to Ordering Guide .....                               | 23        |

**9/99—Rev. B to Rev. C**

# SPECIFICATIONS

## SINGLE SUPPLY

Typical @ 25°C single supply,  $V_S = 5\text{ V}$ , and  $R_L = 10\text{ k}\Omega$ , unless otherwise noted.

Table 1.

| Parameter  | Conditions  | AD623A |      |      | AD623ARM |      |      | AD623B |      |      | Unit                         |
|--|---|--------|------|------|----------|------|------|--------|------|------|------------------------------|
|  |   | Min    | Typ  | Max  | Min      | Typ  | Max  | Min    | Typ  | Max  |                              |
| <b>GAIN</b>  |   |        |      |      |          |      |      |        |      |      |                              |
| Gain Range   | $G = 1 + (100\text{ k}/R_G)$  | 1      |      | 1000 | 1        |      | 1000 | 1      |      | 1000 |                              |
| Gain Error <sup>1</sup>                              | $G1\ V_{OUT} = 0.05\text{ V to }3.5\text{ V}$<br>$G > 1\ V_{OUT} = 0.05\text{ V to }4.5\text{ V}$ |        |      |      |          |      |      |        |      |      |                              |
| G = 1  |   |        | 0.03 | 0.10 |          | 0.03 | 0.10 |        | 0.03 | 0.05 | %                            |
| G = 10   |   |        | 0.10 | 0.35 |          | 0.10 | 0.35 |        | 0.10 | 0.35 | %                            |
| G = 100  |   |        | 0.10 | 0.35 |          | 0.10 | 0.35 |        | 0.10 | 0.35 | %                            |
| G = 1000   |   |        | 0.10 | 0.35 |          | 0.10 | 0.35 |        | 0.10 | 0.35 | %                            |
| <b>Nonlinearity</b>                                  |   |        |      |      |          |      |      |        |      |      |                              |
|  | $G1\ V_{OUT} = 0.05\text{ V to }3.5\text{ V}$<br>$G > 1\ V_{OUT} = 0.05\text{ V to }4.5\text{ V}$ |        |      |      |          |      |      |        |      |      |                              |
| G = 1 to 1000  |   |        | 50   |      |          | 50   |      |        | 50   |      | ppm                          |
| <b>Gain vs. Temperature</b>                          |   |        |      |      |          |      |      |        |      |      |                              |
| G = 1  |   |        | 5    | 10   |          | 5    | 10   |        | 5    | 10   | ppm/°C                       |
| G > 1 <sup>1</sup>                                   |   |        | 50   |      |          | 50   |      |        | 50   |      | ppm/°C                       |
| <b>VOLTAGE OFFSET</b>                                |   |        |      |      |          |      |      |        |      |      |                              |
|  | Total RTI error = $V_{OSI} + V_{OSO}/G$   |        |      |      |          |      |      |        |      |      |                              |
| Input Offset, $V_{OSI}$                              |   |        | 25   | 200  |          | 200  | 500  |        | 25   | 100  | $\mu\text{V}$                |
| Over Temperature                                     |   |        |      | 350  |          |      | 650  |        |      | 160  | $\mu\text{V}$                |
| Average Tempco                                       |   |        | 0.1  | 2    |          | 0.1  | 2    |        | 0.1  | 1    | $\mu\text{V}/^\circ\text{C}$ |
| Output Offset, $V_{OSO}$                             |   |        | 200  | 1000 |          | 500  | 2000 |        | 200  | 500  | $\mu\text{V}$                |
| Over Temperature                                     |   |        |      | 1500 |          |      | 2600 |        |      | 1100 | $\mu\text{V}$                |
| Average Tempco                                       |   |        | 2.5  | 10   |          | 2.5  | 10   |        | 2.5  | 10   | $\mu\text{V}/^\circ\text{C}$ |
| <b>Offset Referred to the Input vs. Supply (PSR)</b> |   |        |      |      |          |      |      |        |      |      |                              |
| G = 1  |   | 80     | 100  |      | 80       | 100  |      | 80     | 100  |      | dB                           |
| G = 10   |   | 100    | 120  |      | 100      | 120  |      | 100    | 120  |      | dB                           |
| G = 100  |   | 120    | 140  |      | 120      | 140  |      | 120    | 140  |      | dB                           |
| G = 1000   |   | 120    | 140  |      | 120      | 140  |      | 120    | 140  |      | dB                           |
| <b>INPUT CURRENT</b>                                 |   |        |      |      |          |      |      |        |      |      |                              |
| Input Bias Current                                   |   |        | 17   | 25   |          | 17   | 25   |        | 17   | 25   | nA                           |
| Over Temperature                                     |   |        |      | 27.5 |          |      | 27.5 |        |      | 27.5 | nA                           |
| Average Tempco                                       |   |        | 25   |      |          | 25   |      |        | 25   |      | pA/°C                        |
| Input Offset Current                                 |   |        | 0.25 | 2    |          | 0.25 | 2    |        | 0.25 | 2    | nA                           |
| Over Temperature                                     |   |        |      | 2.5  |          |      | 2.5  |        |      | 2.5  | nA                           |
| Average Tempco                                       |   |        | 5    |      |          | 5    |      |        | 5    |      | pA/°C                        |

# AD623

| Parameter   | Conditions                        | AD623A          |      |                 | AD623ARM        |      |                 | AD623B          |      |                 | Unit          |
|---|-----------------------------------|-----------------|------|-----------------|-----------------|------|-----------------|-----------------|------|-----------------|---------------|
|   |                                   | Min             | Typ  | Max             | Min             | Typ  | Max             | Min             | Typ  | Max             |               |
| INPUT   |                                   |                 |      |                 |                 |      |                 |                 |      |                 |               |
| Input Impedance   |                                   |                 |      |                 |                 |      |                 |                 |      |                 |               |
| Differential  |                                   |                 | 2  2 |                 |                 | 2  2 |                 |                 | 2  2 |                 | $G\Omega  pF$ |
| Common-Mode   |                                   |                 | 2  2 |                 |                 | 2  2 |                 |                 | 2  2 |                 | $G\Omega  pF$ |
| Input Voltage Range <sup>2</sup>                                  | $V_S = 3V$ to $12V$               | $(-V_S) - 0.15$ |      | $(+V_S) - 1.5$  | $(-V_S) - 0.15$ |      | $(+V_S) - 1.5$  | $(-V_S) - 0.15$ |      | $(+V_S) - 1.5$  | V             |
| Common-Mode Rejection at 60 Hz with 1 k $\Omega$ Source Imbalance |                                   |                 |      |                 |                 |      |                 |                 |      |                 |               |
| G = 1   | $V_{CM} = 0V$ to $3V$             | 70              | 80   |                 | 70              | 80   |                 | 77              | 86   |                 | dB            |
| G = 10  | $V_{CM} = 0V$ to $3V$             | 90              | 100  |                 | 90              | 100  |                 | 94              | 100  |                 | dB            |
| G = 100   | $V_{CM} = 0V$ to $3V$             | 105             | 110  |                 | 105             | 110  |                 | 105             | 110  |                 | dB            |
| G = 1000  | $V_{CM} = 0V$ to $3V$             | 105             | 110  |                 | 105             | 110  |                 | 105             | 110  |                 | dB            |
| OUTPUT  |                                   |                 |      |                 |                 |      |                 |                 |      |                 |               |
| Output Swing  | $R_L = 10\text{ k}\Omega$         | 0.01            |      | $(+V_S) - 0.5$  | 0.01            |      | $(+V_S) - 0.5$  | 0.01            |      | $(+V_S) - 0.5$  | V             |
|   | $R_L = 100\text{ k}\Omega$        | 0.01            |      | $(+V_S) - 0.15$ | 0.01            |      | $(+V_S) - 0.15$ | 0.01            |      | $(+V_S) - 0.15$ | V             |
| DYNAMIC RESPONSE  |                                   |                 |      |                 |                 |      |                 |                 |      |                 |               |
| Small Signal -3 dB Bandwidth                                      |                                   |                 |      |                 |                 |      |                 |                 |      |                 |               |
| G = 1   |                                   |                 | 800  |                 |                 | 800  |                 |                 | 800  |                 | kHz           |
| G = 10  |                                   |                 | 100  |                 |                 | 100  |                 |                 | 100  |                 | kHz           |
| G = 100   |                                   |                 | 10   |                 |                 | 10   |                 |                 | 10   |                 | kHz           |
| G = 1000  |                                   |                 | 2    |                 |                 | 2    |                 |                 | 2    |                 | kHz           |
| Slew Rate   |                                   |                 | 0.3  |                 |                 | 0.3  |                 |                 | 0.3  |                 | V/ $\mu s$    |
| Settling Time to 0.01%  | $V_S = 5V$                        |                 |      |                 |                 |      |                 |                 |      |                 |               |
| G = 1   | Step size: 3.5V                   |                 | 30   |                 |                 | 30   |                 |                 | 30   |                 | $\mu s$       |
| G = 10  | Step size: 4V,<br>$V_{CM} = 1.8V$ |                 | 20   |                 |                 | 20   |                 |                 | 20   |                 | $\mu s$       |

<sup>1</sup> Does not include effects of external resistor,  $R_G$ .

<sup>2</sup> One input grounded.  $G = 1$ .

## DUAL SUPPLIES

Typical @ 25°C dual supply,  $V_S = \pm 5V$ , and  $R_L = 10\text{ k}\Omega$ , unless otherwise noted.

Table 2.

| Parameter               | Conditions  | AD623A |      |      | AD623ARM |      |      | AD623B |      |      | Unit |
|-------------------------|---|--------|------|------|----------|------|------|--------|------|------|------|
|                         |   | Min    | Typ  | Max  | Min      | Typ  | Max  | Min    | Typ  | Max  |      |
| GAIN                    |   |        |      |      |          |      |      |        |      |      |      |
| Gain Range              | $G = 1 + (100\text{ k}/R_G)$  | 1      |      | 1000 | 1        |      | 1000 | 1      |      | 1000 |      |
| Gain Error <sup>1</sup> | $G < 1$ $V_{OUT} = -4.8V$ to $+3.5V$<br>$G > 1$ $V_{OUT} = 0.05V$ to $4.5V$ |        |      |      |          |      |      |        |      |      |      |
| G = 1                   |   |        | 0.03 | 0.10 |          | 0.03 | 0.10 |        | 0.03 | 0.05 | %    |
| G = 10                  |   |        | 0.10 | 0.35 |          | 0.10 | 0.35 |        | 0.10 | 0.35 | %    |
| G = 100                 |   |        | 0.10 | 0.35 |          | 0.10 | 0.35 |        | 0.10 | 0.35 | %    |
| G = 1000                |   |        | 0.10 | 0.35 |          | 0.10 | 0.35 |        | 0.10 | 0.35 | %    |

| Parameter   | Conditions  | AD623A          |      |                 | AD623ARM        |      |                 | AD623B          |      |                 | Unit          |
|---|---|-----------------|------|-----------------|-----------------|------|-----------------|-----------------|------|-----------------|---------------|
|   |   | Min             | Typ  | Max             | Min             | Typ  | Max             | Min             | Typ  | Max             |               |
| Nonlinearity  | $G \geq 1$ $V_{OUT} = -4.8V$ to $+3.5V$<br>$G > 1$ $V_{OUT} = -4.8V$ to $+4.5V$ |                 |      |                 |                 |      |                 |                 |      |                 |               |
| G = 1 to 1000   |   |                 | 50   |                 |                 | 50   |                 |                 | 50   |                 | ppm           |
| Gain vs. Temperature                                      |   |                 |      |                 |                 |      |                 |                 |      |                 |               |
| G = 1   |   |                 | 5    | 10              |                 | 5    | 10              |                 | 5    | 10              | ppm/°C        |
| G > 1 <sup>1</sup>  |   |                 | 50   |                 |                 | 50   |                 |                 | 50   |                 | ppm/°C        |
| VOLTAGE OFFSET  | Total RTI error = $V_{OSI} + V_{OSO}/G$   |                 |      |                 |                 |      |                 |                 |      |                 |               |
| Input Offset, $V_{OSI}$                                   |   |                 | 25   | 200             |                 | 200  | 500             |                 | 25   | 100             | μV            |
| Over Temperature  |   |                 |      | 350             |                 |      | 650             |                 |      | 160             | μV            |
| Average Tempco  |   |                 | 0.1  | 2               |                 | 0.1  | 2               |                 | 0.1  | 1               | μV/°C         |
| Output Offset, $V_{OSO}$                                  |   |                 | 200  | 1000            |                 | 500  | 2000            |                 | 200  | 500             | μV            |
| Over Temperature  |   |                 |      | 1500            |                 |      | 2600            |                 |      | 1100            | μV            |
| Average Tempco  |   |                 | 2.5  | 10              |                 | 2.5  | 10              |                 | 2.5  | 10              | μV/°C         |
| Offset Referred to the Input vs. Supply (PSR)             |   |                 |      |                 |                 |      |                 |                 |      |                 |               |
| G = 1   |   | 80              | 100  |                 | 80              | 100  |                 | 80              | 100  |                 | dB            |
| G = 10  |   | 100             | 120  |                 | 100             | 120  |                 | 100             | 120  |                 | dB            |
| G = 100   |   | 120             | 140  |                 | 120             | 140  |                 | 120             | 140  |                 | dB            |
| G = 1000  |   | 120             | 140  |                 | 120             | 140  |                 | 120             | 140  |                 | dB            |
| INPUT CURRENT   |   |                 |      |                 |                 |      |                 |                 |      |                 |               |
| Input Bias Current  |   |                 | 17   | 25              |                 | 17   | 25              |                 | 17   | 25              | nA            |
| Over Temperature  |   |                 |      | 27.5            |                 |      | 27.5            |                 |      | 27.5            | nA            |
| Average Tempco  |   |                 | 25   |                 |                 | 25   |                 |                 | 25   |                 | pA/°C         |
| Input Offset Current                                      |   |                 | 0.25 | 2               |                 | 0.25 | 2               |                 | 0.25 | 2               | nA            |
| Over Temperature  |   |                 |      | 2.5             |                 |      | 2.5             |                 |      | 2.5             | nA            |
| Average Tempco  |   |                 | 5    |                 |                 | 5    |                 |                 | 5    |                 | pA/°C         |
| INPUT   |   |                 |      |                 |                 |      |                 |                 |      |                 |               |
| Input Impedance   |   |                 |      |                 |                 |      |                 |                 |      |                 |               |
| Differential  |   |                 | 2  2 |                 |                 | 2  2 |                 |                 | 2  2 |                 | $G\Omega  pF$ |
| Common-Mode   |   |                 | 2  2 |                 |                 | 2  2 |                 |                 | 2  2 |                 | $G\Omega  pF$ |
| Input Voltage Range <sup>2</sup>                          | $V_S = +2.5V$ to $\pm 6V$   | $(-V_S) - 0.15$ |      | $(+V_S) - 1.5$  | $(-V_S) - 0.15$ |      | $(+V_S) - 1.5$  | $(-V_S) - 0.15$ |      | $(+V_S) - 1.5$  | V             |
| Common-Mode Rejection at 60 Hz with 1 kΩ Source Imbalance |   |                 |      |                 |                 |      |                 |                 |      |                 |               |
| G = 1   | $V_{CM} = +3.5V$ to $-5.15V$  | 70              | 80   |                 | 70              | 80   |                 | 77              | 86   |                 | dB            |
| G = 10  | $V_{CM} = +3.5V$ to $-5.15V$  | 90              | 100  |                 | 90              | 100  |                 | 94              | 100  |                 | dB            |
| G = 100   | $V_{CM} = +3.5V$ to $-5.15V$  | 105             | 110  |                 | 105             | 110  |                 | 105             | 110  |                 | dB            |
| G = 1000  | $V_{CM} = +3.5V$ to $-5.15V$  | 105             | 110  |                 | 105             | 110  |                 | 105             | 110  |                 | dB            |
| OUTPUT  |   |                 |      |                 |                 |      |                 |                 |      |                 |               |
| Output Swing  | $R_L = 10 k\Omega$ ,<br>$V_S = \pm 5V$  | $(-V_S) + 0.2$  |      | $(+V_S) - 0.5$  | $(-V_S) + 0.2$  |      | $(+V_S) - 0.5$  | $(-V_S) + 0.2$  |      | $(+V_S) - 0.5$  | V             |
|   | $R_L = 100 k\Omega$   | $(-V_S) + 0.05$ |      | $(+V_S) - 0.15$ | $(-V_S) + 0.05$ |      | $(+V_S) - 0.15$ | $(-V_S) + 0.05$ |      | $(+V_S) - 0.15$ | V             |

# AD623

| Parameter                    | Conditions                           | AD623A |     |     | AD623ARM |     |     | AD623B |     |     | Unit |
|------------------------------|--------------------------------------|--------|-----|-----|----------|-----|-----|--------|-----|-----|------|
|                              |                                      | Min    | Typ | Max | Min      | Typ | Max | Min    | Typ | Max |      |
| DYNAMIC RESPONSE             |                                      |        |     |     |          |     |     |        |     |     |      |
| Small Signal –3 dB Bandwidth |                                      |        |     |     |          |     |     |        |     |     |      |
| G = 1                        |                                      |        |     | 800 |          |     | 800 |        |     | 800 | kHz  |
| G = 10                       |                                      |        |     | 100 |          |     | 100 |        |     | 100 | kHz  |
| G = 100                      |                                      |        |     | 10  |          |     | 10  |        |     | 10  | kHz  |
| G = 1000                     |                                      |        |     | 2   |          |     | 2   |        |     | 2   | kHz  |
| Slew Rate                    |                                      |        |     | 0.3 |          |     | 0.3 |        |     | 0.3 | V/μs |
| Settling Time to 0.01%       | $V_S = \pm 5\text{ V}$ ,<br>5 V step |        |     |     |          |     |     |        |     |     |      |
| G = 1                        |                                      |        |     | 30  |          |     | 30  |        |     | 30  | μs   |
| G = 10                       |                                      |        |     | 20  |          |     | 20  |        |     | 20  | μs   |

<sup>1</sup> Does not include effects of external resistor,  $R_G$ .

<sup>2</sup> One input grounded.  $G = 1$ .

## BOTH DUAL AND SINGLE SUPPLIES

Table 3.

| Parameter                       | Conditions  | AD623A |        |            | AD623ARM |        |            | AD623B |        |            | Unit   |     |    |
|---------------------------------|---|--------|--------|------------|----------|--------|------------|--------|--------|------------|--------|-----|----|
|                                 |   | Min    | Typ    | Max        | Min      | Typ    | Max        | Min    | Typ    | Max        |        |     |    |
| NOISE                           |   |        |        |            |          |        |            |        |        |            |        |     |    |
| Voltage Noise, 1 kHz            | Total RTI noise =<br>$\sqrt{(e_{ni})^2 + (e_{no}/G)^2}$ |        |        |            |          |        |            |        |        |            |        |     |    |
| Input, Voltage Noise, $e_{ni}$  |   |        |        | 35         |          |        | 35         |        |        | 35         | nV/√Hz |     |    |
| Output, Voltage Noise, $e_{no}$ |   |        |        | 50         |          |        | 50         |        |        | 50         | nV/√Hz |     |    |
| RTI, 0.1 Hz to 10 Hz            | $f = 1\text{ kHz}$                                      |        |        |            |          |        |            |        |        |            |        |     |    |
| G = 1                           |   |        |        | 3.0        |          |        | 3.0        |        |        | 3.0        | μV p-p |     |    |
| G = 1000                        |   |        |        | 1.5        |          |        | 1.5        |        |        | 1.5        | μV p-p |     |    |
| Current Noise                   | $f = 1\text{ kHz}$                                      |        |        | 100        |          |        | 100        |        |        | 100        | fA/√Hz |     |    |
| 0.1 Hz to 10 Hz                 |   |        |        | 1.5        |          |        | 1.5        |        |        | 1.5        | pA p-p |     |    |
| REFERENCE INPUT                 |   |        |        |            |          |        |            |        |        |            |        |     |    |
| $R_{IN}$                        | $V_{IN+}, V_{REF} = 0\text{ V}$                         |        |        | 100 ± 20%  |          |        | 100 ± 20%  |        |        | 100 ± 20%  | kΩ     |     |    |
| $I_{IN}$                        |   |        |        | 50         | 60       | 50     | 60         |        |        | 50         | 60     | μA  |    |
| Voltage Range                   |   |        | $-V_S$ |            | $+V_S$   | $-V_S$ |            | $+V_S$ | $-V_S$ |            | $+V_S$ | V   |    |
| Gain to Output                  |   |        |        | 1 ± 0.0002 |          |        | 1 ± 0.0002 |        |        | 1 ± 0.0002 | V      |     |    |
| POWER SUPPLY                    |   |        |        |            |          |        |            |        |        |            |        |     |    |
| Operating Range                 | Dual supply   | ±2.5   |        | ±6         | ±2.5     |        | ±6         | ±2.5   |        | ±6         | V      |     |    |
|                                 | Single supply   | 2.7    |        | 12         | 2.7      |        | 12         | 2.7    |        | 12         | V      |     |    |
| Quiescent Current               | Dual supply   |        | 375    | 550        |          | 375    | 550        |        | 375    | 550        | μA     |     |    |
|                                 | Single supply   |        | 305    | 480        |          | 305    | 480        |        | 305    | 480        | μA     |     |    |
| Over Temperature                |   |        |        | 625        |          |        | 625        |        |        | 625        | μA     |     |    |
| TEMPERATURE RANGE               |   |        |        |            |          |        |            |        |        |            |        |     |    |
| For Specified Performance       |   |        |        | –40        |          |        | +85        |        |        | –40        |        | +85 | °C |

## ABSOLUTE MAXIMUM RATINGS

Table 4.

| Parameter                               | Rating          |
|---|-----------------|
| Supply Voltage                          | $\pm 6$ V       |
| Internal Power Dissipation <sup>1</sup> | 650 mW          |
| Differential Input Voltage              | $\pm 6$ V       |
| Output Short-Circuit Duration           | Indefinite      |
| Storage Temperature Range               | -65°C to +125°C |
| Operating Temperature Range             | -40°C to +85°C  |
| Lead Temperature (Soldering, 10 sec)    | 300°C           |

<sup>1</sup> Specification is for device in free air:

8-Lead PDIP Package:  $\theta_{JA} = 95^{\circ}\text{C}/\text{W}$

8-Lead SOIC Package:  $\theta_{JA} = 155^{\circ}\text{C}/\text{W}$

8-Lead MSOP Package:  $\theta_{JA} = 200^{\circ}\text{C}/\text{W}$ .

Stresses above those listed under Absolute Maximum Ratings may cause permanent damage to the device. This is a stress rating only; functional operation of the device at these or any other conditions above those indicated in the operational section of this specification is not implied. Exposure to absolute maximum rating conditions for extended periods may affect device reliability.

### ESD CAUTION



**ESD (electrostatic discharge) sensitive device.**

Charged devices and circuit boards can discharge without detection. Although this product features patented or proprietary protection circuitry, damage may occur on devices subjected to high energy ESD. Therefore, proper ESD precautions should be taken to avoid performance degradation or loss of functionality.

TYPICAL PERFORMANCE CHARACTERISTICS

At 25°C,  $V_S = \pm 5\text{ V}$ , and  $R_L = 10\text{ k}\Omega$ , unless otherwise noted.



Figure 3. Typical Distribution of Input Offset Voltage; Package Option N-8, R-8



Figure 6. Typical Distribution of Output Offset Voltage,  $V_S = 5\text{ V}$ , Single Supply,  $V_{REF} = -0.125\text{ V}$ ; Package Option N-8, R-8



Figure 4. Typical Distribution of Output Offset Voltage; Package Option N-8, R-8



Figure 7. Typical Distribution for Input Offset Current; Package Option N-8, R-8

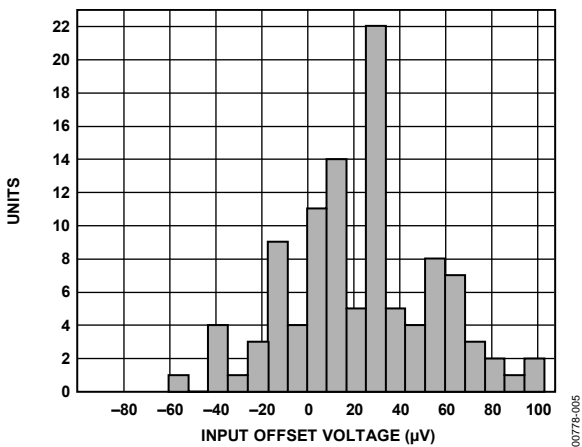

Figure 5. Typical Distribution of Input Offset Voltage,  $V_S = 5\text{ V}$ , Single Supply,  $V_{REF} = -0.125\text{ V}$ ; Package Option N-8, R-8

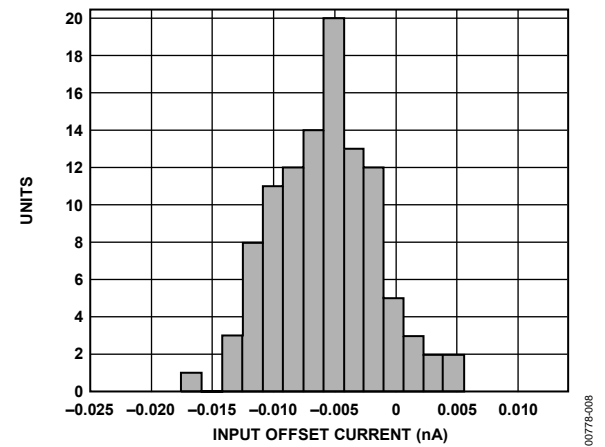

Figure 8. Typical Distribution for Input Offset Current,  $V_S = 5\text{ V}$ , Single Supply,  $V_{REF} = -0.125\text{ V}$ ; Package Option N-8, R-8





Figure 9. Typical Distribution for CMRR (G = 1)



Figure 12. I<sub>BIAS</sub> vs. Temperature



Figure 10. Voltage Noise Spectral Density vs. Frequency



Figure 13. Current Noise Spectral Density vs. Frequency



Figure 11. I<sub>BIAS</sub> vs. CMV, V<sub>S</sub> = ±5 V



Figure 14. I<sub>BIAS</sub> vs. CMV, V<sub>S</sub> = ±2.5 V



Figure 15. 0.1 Hz to 10 Hz Current Noise (0.71 pA/DIV)



Figure 16. 0.1 Hz to 10 Hz RTI Voltage Noise (1 DIV = 1 µV p-p)



Figure 17. CMR vs. Frequency,  $V_S = 5V_S, 0V_S, V_{REF} = 2.5V$



Figure 18. CMR vs. Frequency,  $\pm 5V_S$



Figure 19. Gain vs. Frequency ( $V_S = 5V, 0V, V_{REF} = 2.5V$ )



Figure 20. Maximum Output Voltage vs. Common-Mode Input,  $G = 1, R_L = 100k\Omega$



Figure 21. Maximum Output Voltage vs. Common-Mode Input,  $G \geq 10$ ,  $R_L = 100 \Omega$



Figure 24. Positive PSRR vs. Frequency,  $\pm 5 V_S$



Figure 22. Maximum Output Voltage vs. Common-Mode Input,  $G = 1$ ,  $V_S = 5 V$ ,  $R_L = 100 k\Omega$



Figure 25. Positive PSRR vs. Frequency,  $5 V_S, 0 V_S$

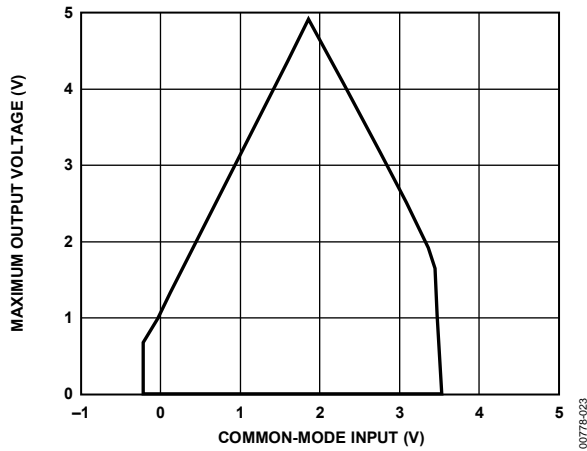

Figure 23. Maximum Output Voltage vs. Common-Mode Input,  $G \geq 10$ ,  $V_S = 5 V$ ,  $R_L = 100 k\Omega$

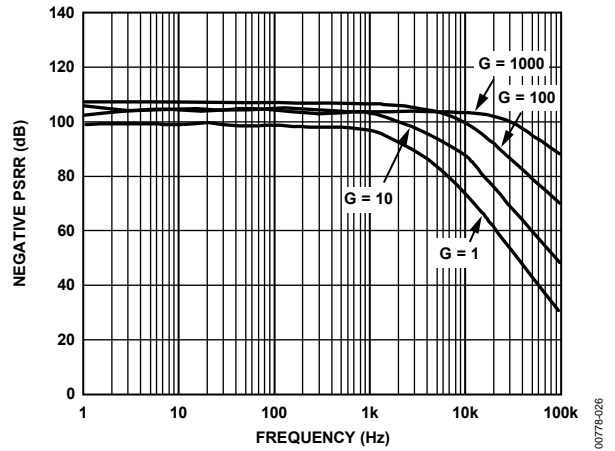

Figure 26. Negative PSRR vs. Frequency,  $\pm 5 V_S$

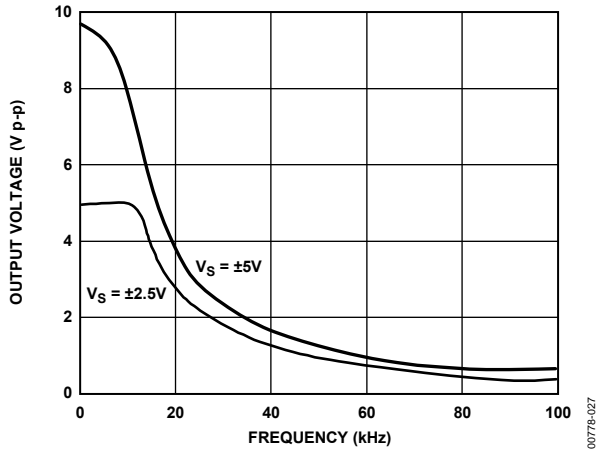

Figure 27. Large Signal Response,  $G \leq 10$



Figure 28. Settling Time to 0.01% vs. Gain, for a 5 V Step at Output,  $C_L = 100 pF$ ,  $V_S = \pm 5 V$



Figure 29. Large Signal Pulse Response and Settling Time,  $G = -1$  ( $0.250 mV = 0.01%$ ),  $C_L = 100 pF$



Figure 30. Large Signal Pulse Response and Settling Time,  $G = -10$  ( $0.250 mV = 0.01%$ ),  $C_L = 100 pF$



Figure 31. Large Signal Pulse Response and Settling Time,  $G = 100$ ,  $C_L = 100 pF$



Figure 32. Large Signal Pulse Response and Settling Time,  $G = -1000$  ( $5 mV = 0.01%$ ),  $C_L = 100 pF$



Figure 33. Small Signal Pulse Response,  $G = 1$ ,  $R_L = 10\text{ k}\Omega$ ,  $C_L = 100\text{ pF}$



Figure 36. Small Signal Pulse Response,  $G = 1000$ ,  $R_L = 10\text{ k}\Omega$ ,  $C_L = 100\text{ pF}$



Figure 34. Small Signal Pulse Response,  $G = 10$ ,  $R_L = 10\text{ k}\Omega$ ,  $C_L = 100\text{ pF}$



Figure 37. Gain Nonlinearity,  $G = -1$  (50 ppm/DIV)



Figure 35. Small Signal Pulse Response,  $G = 100$ ,  $R_L = 10\text{ k}\Omega$ ,  $C_L = 100\text{ pF}$



Figure 38. Gain Nonlinearity,  $G = -10$  (6 ppm/DIV)



Figure 39. Gain Nonlinearity,  $G = -100$ , 15 ppm/DIV



Figure 40. Output Voltage Swing vs. Output Current

## THEORY OF OPERATION

The AD623 is an instrumentation amplifier based on a modified classic 3-op-amp approach, to assure single or dual supply operation even at common-mode voltages at the negative supply rail. Low voltage offsets, input and output, as well as absolute gain accuracy, and one external resistor to set the gain, make the AD623 one of the most versatile instrumentation amplifiers in its class.

The input signal is applied to PNP transistors acting as voltage buffers and providing a common-mode signal to the input amplifiers (see Figure 41). An absolute value 50 kΩ resistor in each amplifier feedback assures gain programmability.

The differential output is

$$V_O = \left( 1 + \frac{100 \text{ k}\Omega}{R_G} \right) V_C$$

The differential voltage is then converted to a single-ended voltage using the output amplifier, which also rejects any common-mode signal at the output of the input amplifiers.

Because the amplifiers can swing to either supply rail, as well as have their common-mode range extended to below the negative supply rail, the range over which the AD623 can operate is further enhanced (see Figure 20 and Figure 21).

The output voltage at Pin 6 is measured with respect to the potential at Pin 5. The impedance of the reference pin is 100 kΩ; therefore, in applications requiring V/I conversion, a small resistor between Pin 5 and Pin 6 is all that is needed.



Figure 41. Simplified Schematic

Note that the bandwidth of the in-amp decreases as gain is increased. This occurs because the internal op-amps are the standard voltage feedback design. At unity gain, the output amplifier limits the bandwidth.

## APPLICATIONS INFORMATION

### BASIC CONNECTION

Figure 42 and Figure 43 show the basic connection circuits for the AD623. The  $+V_S$  and  $-V_S$  terminals are connected to the power supply. The supply can be either bipolar ( $V_S = \pm 2.5$  V to  $\pm 6$  V) or single supply ( $-V_S = 0$  V,  $+V_S = 3.0$  V to 12 V). Power supplies should be capacitively decoupled close to the power pins of the device. For the best results, use surface-mount  $0.1 \mu\text{F}$  ceramic chip capacitors and  $10 \mu\text{F}$  electrolytic tantalum capacitors.



Figure 42. Dual-Supply Basic Connection



Figure 43. Single-Supply Basic Connection

The input voltage, which can be either single-ended (tie either  $-IN$  or  $+IN$  to ground), or differential is amplified by the programmed gain. The output signal appears as the voltage difference between the OUTPUT pin and the externally applied voltage on the REF input. For a ground-referenced output, REF should be grounded.

### GAIN SELECTION

The gain of the AD623 is resistor programmed by  $R_G$ , or more precisely, by whatever impedance appears between Pin 1 and Pin 8. The AD623 is designed to offer accurate gains using 0.1% to 1% tolerance resistors. Table 5 shows the required values of  $R_G$  for the various gains. Note that for  $G = 1$ , the  $R_G$  terminals are unconnected ( $R_G = \infty$ ). For any arbitrary gain,  $R_G$  can be calculated by

$$R_G = 100 \text{ k}\Omega / (G - 1)$$

### REFERENCE TERMINAL

The reference terminal potential defines the zero output voltage and is especially useful when the load does not share a precise ground with the rest of the system. It provides a direct means of injecting a precise offset to the output. The reference terminal is also useful when bipolar signals are being amplified because it can be used to provide a virtual ground voltage. The voltage on the reference terminal can be varied from  $-V_S$  to  $+V_S$ .

Table 5. Required Values of Gain Resistors

| Desired Gain | 1% Standard Table Value of $R_G$ ( $\Omega$ ) | Calculated Gain Using 1% Resistors |
|--------------|---|------------------------------------|
| 2            | 100 k   | 2                                  |
| 5            | 24.9 k  | 5.02                               |
| 10           | 11 k  | 10.09                              |
| 20           | 5.23 k  | 20.12                              |
| 33           | 3.09 k  | 33.36                              |
| 40           | 2.55 k  | 40.21                              |
| 50           | 2.05 k  | 49.78                              |
| 65           | 1.58 k  | 64.29                              |
| 100          | 1.02 k  | 99.04                              |
| 200          | 499   | 201.4                              |
| 500          | 200   | 501                                |
| 1000         | 100   | 1001                               |



**INPUT AND OUTPUT OFFSET VOLTAGE**

The low errors of the AD623 are attributed to two sources, input and output errors. The output error is divided by the programmed gain when referred to the input. In practice, the input errors dominate at high gains and the output errors dominate at low gains. The total  $V_{OS}$  for a given gain is calculated as the following:

$$Total\ Error\ RTI = Input\ Error + (Output\ Error/G)$$

$$Total\ Error\ RTO = (Input\ Error \times G) + Output\ Error$$

RTI offset errors and noise voltages for different gains are shown in Table 6.

**INPUT PROTECTION**

Internal supply referenced clamping diodes allow the input, reference, output, and gain terminals of the AD623 to safely withstand overvoltages of 0.3 V above or below the supplies. This is true for all gains and for power on and power off. This last case is particularly important because the signal source and amplifier may be powered separately.

If the overvoltage is expected to exceed this value, the current through these diodes should be limited to about 10 mA using external current limiting resistors (see Figure 44). The size of this resistor is defined by the supply voltage and the required overvoltage protection.



Figure 44. Input Protection

**RF INTERFERENCE**

All instrumentation amplifiers can rectify high frequency out-of-band signals. Once rectified, these signals appear as dc offset errors at the output. The circuit in Figure 45 provides good RFI suppression without reducing performance within the pass band of

the in-amp. Resistor R1 and Capacitor C1 (and likewise, R2 and C2) form a low-pass RC filter that has a  $-3$  dB bandwidth equal to  $F = 1/(2 \pi R1C1)$ . Using the component values shown, this filter has a  $-3$  dB bandwidth of approximately 40 kHz. Resistors R1 and R2 were selected to be large enough to isolate the input of the circuit from the capacitors, but not large enough to significantly increase the noise of the circuit. To preserve common-mode rejection in the amplifier's pass band, Capacitors C1 and C2 need to be 5% or better units, or low cost 20% units can be tested and binned to provide closely matched devices.



NOTES:  
1. LOCATE C1 TO C3 AS CLOSE TO THE INPUT PINS AS POSSIBLE.

Figure 45. Circuit to Attenuate RF Interference

Capacitor C3 is needed to maintain common-mode rejection at the low frequencies. R1/R2 and C1/C2 form a bridge circuit whose output appears across the input pins of the in-amp. Any mismatch between C1 and C2 unbalances the bridge and reduces the common-mode rejection. C3 ensures that any RF signals are common mode (the same on both in-amp inputs) and are not applied differentially. This second low-pass network, R1 + R2 and C3, has a  $-3$  dB frequency equal to  $1/(2 \pi (R1 + R2) (C3))$ . Using a C3 value of 0.047  $\mu$ F, the  $-3$  dB signal bandwidth of this circuit is approximately 400 Hz. The typical dc offset shift over frequency is less than 1.5  $\mu$ V and the circuit's RF signal rejection is better than 71 dB. The 3 dB signal bandwidth of this circuit may be increased to 900 Hz by reducing Resistors R1 and R2 to 2.2 k $\Omega$ . The performance is similar to using 4 k $\Omega$  resistors, except that the circuitry preceding the in-amp must drive a lower impedance load.

Table 6. RTI Error Sources

| Gain | Maximum Total Input Offset Error ( $\mu$ V) |        | Maximum Total Input Offset Drift ( $\mu$ V/ $^{\circ}$ C) |        | Total Input Referred Noise (nV/ $\sqrt$ Hz) |
|------|---|--------|---|--------|---|
|      | AD623A                                      | AD623B | AD623A  | AD623B | AD623A and AD623B                           |
| 1    | 1200  | 600    | 12  | 11     | 62  |
| 2    | 700   | 350    | 7   | 6      | 45  |
| 5    | 400   | 200    | 4   | 3      | 38  |
| 10   | 300   | 150    | 3   | 2      | 35  |
| 20   | 250   | 125    | 2.5   | 1.5    | 35  |
| 50   | 220   | 110    | 2.2   | 1.2    | 35  |
| 100  | 210   | 105    | 2.1   | 1.1    | 35  |
| 1000 | 200   | 100    | 2   | 1      | 35  |

# AD623

The circuit in Figure 45 should be built using a PC board with a ground plane on both sides. All component leads should be as short as possible. Resistors R1 and R2 can be common 1% metal film units, but Capacitors C1 and C2 need to be  $\pm 5\%$  tolerance devices to avoid degrading the circuit's common-mode rejection. Either the traditional 5% silver mica units or Panasonic  $\pm 2\%$  PPS film capacitors are recommended.

In many applications, shielded cables are used to minimize noise; for best CMR over frequency, the shield should be properly driven. Figure 46 shows an active guard driver that is configured to improve ac common-mode rejection by bootstrapping the capacitances of input cable shields, thus minimizing the capacitance mismatch between the inputs.



Figure 46. Common-Mode Shield Driver

## GROUNDING

Because the AD623 output voltage is developed with respect to the potential on the reference terminal, many grounding problems can be solved by simply tying the REF pin to the appropriate local

ground. The REF pin should, however, be tied to a low impedance point for optimal CMR.

The use of ground planes is recommended to minimize the impedance of ground returns (and hence the size of dc errors). To isolate low level analog signals from a noisy digital environment, many data acquisition components have separate analog and digital ground returns (see Figure 47). All ground pins from mixed signal components, such as analog-to-digital converters (ADCs), should be returned through the high quality analog ground plane. Maximum isolation between analog and digital is achieved by connecting the ground planes back at the supplies. The digital return currents from the ADC that flow in the analog ground plane, in general, have a negligible effect on noise performance.

If there is only a single power supply available, it must be shared by both digital and analog circuitry. Figure 48 shows how to minimize interference between the digital and analog circuitry.

As in the previous case, separate analog and digital ground planes should be used (reasonably thick traces can be used as an alternative to a digital ground plane). These ground planes should be connected at the ground pin of the power supply. Separate traces should be run from the power supply to the supply pins of the digital and analog circuits. Ideally, each device should have its own power supply trace, but these can be shared by a number of devices, as long as a single trace is not used to route current to both digital and analog circuitry.



Figure 47. Optimal Grounding Practice for a Bipolar Supply Environment with Separate Analog and Digital Supplies



Figure 48. Optimal Ground Practice in a Single Supply Environment

**Ground Returns for Input Bias Currents**

Input bias currents are those dc currents that must flow to bias the input transistors of an amplifier. These are usually transistor base currents. When amplifying floating input sources, such as transformers or ac-coupled sources, there must be a direct dc path into each input in order that the bias current can flow. Figure 49, Figure 50, and Figure 51 show how a bias current path can be provided for the cases of transformer coupling, thermocouple, and capacitive ac coupling. In dc-coupled resistive bridge applications, providing this path is generally not necessary as the bias current simply flows from the bridge supply through the bridge into the amplifier. However, if the impedances that the two inputs see are large and differ by a large amount (>10 kΩ), the offset current of the input stage causes dc errors proportional with the input offset voltage of the amplifier.



Figure 49. Ground Returns for Bias Currents with Transformer-Coupled Inputs

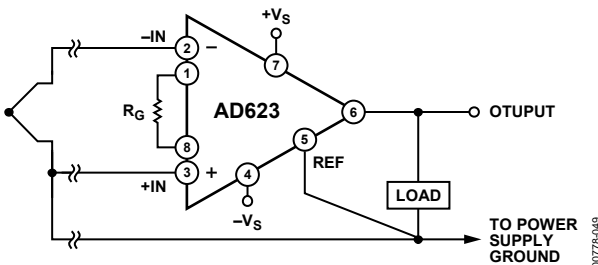

Figure 50. Ground Returns for Bias Currents with Thermocouple Inputs



Figure 51. Ground Returns for Bias Currents with AC-Coupled Inputs

**Output Buffering**

The AD623 is designed to drive loads of 10 kΩ or greater. If the load is less than this value, the output of the AD623 should be buffered with a precision single-supply op amp, such as the OP113. This op amp can swing from 0 V to 4 V on its output while driving a load as small as 600 Ω. Table 7 summarizes the performance of some buffer op amps.



Figure 52. Output Buffering

**Table 7. Buffering Options**

| Op Amp | Description                                       |
|--------|---|
| OP113  | Single supply, high output current                |
| OP191  | Rail-to-rail input and output, low supply current |

**Single-Supply Data Acquisition System**

Interfacing bipolar signals to single-supply ADCs presents a challenge. The bipolar signal must be mapped into the input range of the ADC. Figure 53 shows how this translation can be achieved.

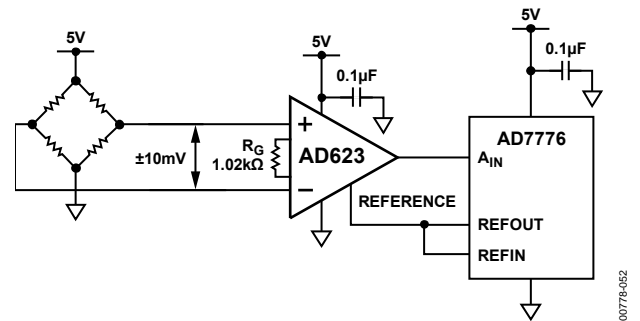

Figure 53. A Single-Supply Data Acquisition System

The bridge circuit is excited by a 5 V supply. The full-scale output voltage from the bridge ( $\pm 10$  mV) therefore has a common-mode level of 2.5 V. The AD623 removes the common-mode component and amplifies the input signal by a factor of 100 ( $R_{GAIN} = 1.02$  kΩ). This results in an output signal of  $\pm 1$  V. To prevent this signal from running into the ground rail of the AD623, the voltage on the REF pin must be raised to at least 1 V. In this example, the 2 V reference voltage from the AD7776 ADC is used to bias the output voltage of the AD623 to  $2$  V  $\pm 1$  V. This corresponds to the input range of the ADC.

# AD623

## Amplifying Signals with Low Common-Mode Voltage

Because the common-mode input range of the AD623 extends 0.1 V below ground, it is possible to measure small differential signals which have low, or no, common-mode component. Figure 54 shows a thermocouple application where one side of the J-type thermocouple is grounded.

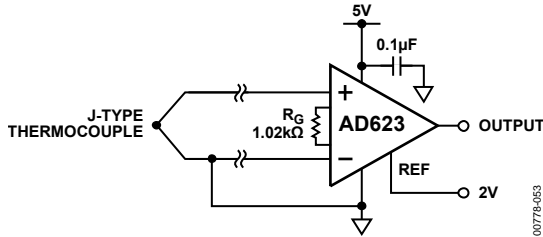

Figure 54. Amplifying Bipolar Signals with Low Common-Mode Voltage

Over a temperature range of  $-200^{\circ}\text{C}$  to  $+200^{\circ}\text{C}$ , the J-type thermocouple delivers a voltage ranging from  $-7.890\text{ mV}$  to  $+10.777\text{ mV}$ . A programmed gain on the AD623 of 100 ( $R_G = 1.02\text{ k}\Omega$ ) and a voltage on the REF pin of 2 V, results in the output voltage ranging from 1.110 V to 3.077 V relative to ground.

## INPUT DIFFERENTIAL AND COMMON-MODE RANGE vs. SUPPLY AND GAIN

Figure 55 shows a simplified block diagram of the AD623. The voltages at the outputs of Amplifier A1 and Amplifier A2 are given by

$$\begin{aligned} V_{A2} &= V_{CM} + V_{DIFF}/2 + 0.6\text{ V} + V_{DIFF} \times R_F/R_G \\ &= V_{CM} + 0.6\text{ V} + V_{DIFF} \times \text{Gain}/2 \end{aligned}$$

$$\begin{aligned} V_{A1} &= V_{CM} + V_{DIFF}/2 + 0.6\text{ V} + V_{DIFF} \times R_F/R_G \\ &= V_{CM} + 0.6\text{ V} - V_{DIFF} \times \text{Gain}/2 \end{aligned}$$



Figure 55. Simplified Block Diagram

The voltages on these internal nodes are critical in determining whether the output voltage will be clipped. The  $V_{A1}$  and  $V_{A2}$  voltages can swing from approximately 10 mV above the negative supply ( $V^-$  or ground) to within approximately 100 mV of the positive rail before clipping occurs. Based on this and from

the previous equations, the maximum and minimum input common-mode voltages are given by the following equations:

$$V_{CM\text{MAX}} = V^+ - 0.7\text{ V} - V_{DIFF} \times \text{Gain}/2$$

$$V_{CM\text{MIN}} = V^- - 0.590\text{ V} + V_{DIFF} \times \text{Gain}/2$$

These equations can be rearranged to give the maximum possible differential voltage (positive or negative) for a particular common-mode voltage, gain, and power supply. Because the signals on A1 and A2 can clip on either rail, the maximum differential voltage are the lesser of the two equations.

$$|V_{DIFF\text{MAX}}| = 2 (V^+ - 0.7\text{ V} - V_{CM})/\text{Gain}$$

$$|V_{DIFF\text{MAX}}| = 2 (V_{CM} - V^- + 0.590\text{ V})/\text{Gain}$$

However, the range on the differential input voltage range is also constrained by the output swing. Therefore, the range of  $V_{DIFF}$  may have to be lower according the following equation.

$$\text{Input Range} \leq \text{Available Output Swing}/\text{Gain}$$

For a bipolar input voltage with a common-mode voltage that is roughly half way between the rails,  $V_{DIFF\text{MAX}}$  is half the value that the previous equations yield because the REF pin is at midsupply. Note that the available output swing is given for different supply conditions in the Specifications section.

The equations can be rearranged to give the maximum gain for a fixed set of input conditions. Again, the maximum gain will be the lesser of the two equations.

$$\text{Gain}_{\text{MAX}} = 2 (V^+ - 0.7\text{ V} - V_{CM})/V_{DIFF}$$

$$\text{Gain}_{\text{MAX}} = 2 (V_{CM} - V^- + 0.590\text{ V})/V_{DIFF}$$

Again, it is recommended that the resulting gain times the input range is less than the available output swing. If this is not the case, the maximum gain is given by

$$\text{Gain}_{\text{MAX}} = \text{Available Output Swing}/\text{Input Range}$$

Also for bipolar inputs (that is, input range =  $2 V_{DIFF}$ ), the maximum gain is half the value yielded by the previous equations because the REF pin must be at midsupply.

The maximum gain and resulting output swing for different input conditions is given in Table 8. Output voltages are referenced to the voltage on the REF pin.

For the purposes of computation, it is necessary to break down the input voltage into its differential and common-mode component. Therefore, when one of the inputs is grounded or at a fixed voltage, the common-mode voltage changes as the differential voltage changes. Take the case of the thermocouple amplifier in Figure 54. The inverting input on the AD623 is grounded; therefore, when the input voltage is  $-10\text{ mV}$ , the voltage on the noninverting input is  $-10\text{ mV}$ . For the purpose of the signal swing calculations, this input voltage should be composed of a common-mode voltage of  $-5\text{ mV}$  (that is,  $(+IN + -IN)/2$ ) and a differential input voltage of  $-10\text{ mV}$  (that is,  $+IN - -IN$ ).

Table 8. Maximum Attainable Gain and Resulting Output Swing for Different Input Conditions

| $V_{CM}$ (V) | $V_{DIFF}$ (V) | REF Pin (V) | Supply Voltages (V) | Maximum Gain | Closest 1% Gain Resistor ( $\Omega$ ) | Resulting Gain | Output Swing (V) |
|--------------|----------------|-------------|---------------------|--------------|---------------------------------------|----------------|------------------|
| 0            | $\pm 10$ m     | 2.5         | +5                  | 118          | 866                                   | 116            | $\pm 1.2$        |
| 0            | $\pm 100$ m    | 2.5         | +5                  | 11.8         | 9.31 k                                | 11.7           | $\pm 1.1$        |
| 0            | $\pm 10$ m     | 0           | $\pm 5$             | 490          | 205                                   | 488            | $\pm 4.8$        |
| 0            | $\pm 100$ m    | 0           | $\pm 5$             | 49           | 2.1 k                                 | 48.61          | $\pm 4.8$        |
| 0            | $\pm 1$        | 0           | $\pm 5$             | 4.9          | 26.1 k                                | 4.83           | $\pm 4.8$        |
| 2.5          | $\pm 10$ m     | 2.5         | +5                  | 242          | 422                                   | 238            | $\pm 2.3$        |
| 2.5          | $\pm 100$ m    | 2.5         | +5                  | 24.2         | 4.32 k                                | 24.1           | $\pm 2.4$        |
| 2.5          | $\pm 1$        | 2.5         | +5                  | 2.42         | 71.5 k                                | 2.4            | $\pm 2.4$        |
| 1.5          | $\pm 10$ m     | 1.5         | +3                  | 142          | 715                                   | 141            | $\pm 1.4$        |
| 1.5          | $\pm 100$ m    | 1.5         | +3                  | 14.2         | 7.68 k                                | 14             | $\pm 1.4$        |
| 0            | $\pm 10$ m     | 1.5         | +3                  | 118          | 866                                   | 116            | $\pm 1.1$        |
| 0            | $\pm 100$ m    | 1.5         | +3                  | 11.8         | 9.31 k                                | 11.74          | $\pm 1.1$        |

OUTLINE DIMENSIONS



COMPLIANT TO JEDEC STANDARDS MS-001  
 CONTROLLING DIMENSIONS ARE IN INCHES; MILLIMETER DIMENSIONS (IN PARENTHESES) ARE ROUNDED-OFF INCH EQUIVALENTS FOR REFERENCE ONLY AND ARE NOT APPROPRIATE FOR USE IN DESIGN. CORNER LEADS MAY BE CONFIGURED AS WHOLE OR HALF LEADS.

Figure 56. 8-Lead Plastic Dual In-Line Package [PDIP] Narrow Body (N-8)  
 Dimensions shown in inches and (millimeters)

070606-A



COMPLIANT TO JEDEC STANDARDS MS-012-AA  
 CONTROLLING DIMENSIONS ARE IN MILLIMETERS; INCH DIMENSIONS (IN PARENTHESES) ARE ROUNDED-OFF MILLIMETER EQUIVALENTS FOR REFERENCE ONLY AND ARE NOT APPROPRIATE FOR USE IN DESIGN.

Figure 57. 8-Lead Standard Small Outline Package [SOIC\_N] Narrow Body (R-8)  
 Dimensions shown in millimeters and (inches)

012407-A



COMPLIANT TO JEDEC STANDARDS MO-187-AA

Figure 58. 8-Lead Mini Small Outline Package [MSOP] (RM-8)

Dimensions shown in millimeters

**ORDERING GUIDE**

| Model                        | Temperature Range | Package Description   | Package Option | Branding |
|------------------------------|-------------------|---|----------------|----------|
| AD623AN                      | -40°C to +85°C    | 8-Lead Plastic Dual In-Line Package [PDIP]                        | N-8            |          |
| AD623ANZ <sup>1</sup>        | -40°C to +85°C    | 8-Lead Plastic Dual In-Line Package [PDIP]                        | N-8            |          |
| AD623AR                      | -40°C to +85°C    | 8-Lead Standard Small Outline Package [SOIC_N]                    | R-8            |          |
| AD623AR-REEL                 | -40°C to +85°C    | 8-Lead Standard Small Outline Package [SOIC_N], 13" Tape and Reel | R-8            |          |
| AD623AR-REEL7                | -40°C to +85°C    | 8-Lead Standard Small Outline Package [SOIC_N], 7" Tape and Reel  | R-8            |          |
| AD623ARZ <sup>1</sup>        | -40°C to +85°C    | 8-Lead Standard Small Outline Package [SOIC_N]                    | R-8            |          |
| AD623ARZ-R7 <sup>1</sup>     | -40°C to +85°C    | 8-Lead Standard Small Outline Package [SOIC_N], 7" Tape and Reel  | R-8            |          |
| AD623ARZ-RL <sup>1</sup>     | -40°C to +85°C    | 8-Lead SOIC, 13" Tape and Reel                                    | R-8            |          |
| AD623ARM                     | -40°C to +85°C    | 8-Lead Mini Small Outline Package [MSOP]                          | RM-8           | JOA      |
| AD623ARM-REEL                | -40°C to +85°C    | 8-Lead Mini Small Outline Package [MSOP], 13" Tape and Reel       | RM-8           | JOA      |
| AD623ARM-REEL7               | -40°C to +85°C    | 8-Lead Mini Small Outline Package [MSOP], 7" Tape and Reel        | RM-8           | JOA      |
| AD623ARMZ <sup>1</sup>       | -40°C to +85°C    | 8-Lead Mini Small Outline Package [MSOP]                          | RM-8           | JOA      |
| AD623ARMZ-REEL <sup>1</sup>  | -40°C to +85°C    | 8-Lead Mini Small Outline Package [MSOP], 13" Tape and Reel       | RM-8           | JOA      |
| AD623ARMZ-REEL7 <sup>1</sup> | -40°C to +85°C    | 8-Lead Mini Small Outline Package [MSOP], 7" Tape and Reel        | RM-8           | JOA      |
| AD623BN                      | -40°C to +85°C    | 8-Lead Plastic Dual In-Line Package [PDIP]                        | N-8            |          |
| AD623BNZ <sup>1</sup>        | -40°C to +85°C    | 8-Lead Plastic Dual In-Line Package [PDIP]                        | N-8            |          |
| AD623BR                      | -40°C to +85°C    | 8-Lead Standard Small Outline Package [SOIC_N]                    | R-8            |          |
| AD623BR-REEL                 | -40°C to +85°C    | 8-Lead Standard Small Outline Package [SOIC_N], 13" Tape and Reel | R-8            |          |
| AD623BR-REEL7                | -40°C to +85°C    | 8-Lead Standard Small Outline Package [SOIC_N], 7" Tape and Reel  | R-8            |          |
| AD623BRZ <sup>1</sup>        | -40°C to +85°C    | 8-Lead Standard Small Outline Package [SOIC_N]                    | R-8            |          |
| AD623BRZ-R7 <sup>1</sup>     | -40°C to +85°C    | 8-Lead Standard Small Outline Package [SOIC_N], 7" Tape and Reel  | R-8            |          |
| AD623BRZ-RL <sup>1</sup>     | -40°C to +85°C    | 8-Lead Standard Small Outline Package [SOIC_N], 13" Tape and Reel | R-8            |          |
| EVAL-INAMP-62RZ <sup>1</sup> |                   | Evaluation Board  |                |          |

<sup>1</sup> Z = RoHS Compliant Part.

**AD623**

**NOTES**