



SFA1601G THRU SFA1608G

16.0 AMPS. Glass Passivated Super Fast Rectifiers



Voltage Range
50 to 600 Volts
Current
16.0 Amperes

Features

- ✧ Low forward voltage drop
- ✧ High current capability
- ✧ High reliability
- ✧ High surge current capability

Mechanical Data

- ✧ Cases: Molded plastic
- ✧ Epoxy: UL 94V-O rate flame retardant
- ✧ Terminals: Leads solderable per MIL-STD-202, Method 208 guaranteed
- ✧ Polarity: As marked
- ✧ High temperature soldering guaranteed: 260°C/10 seconds .16", (4.06mm) from case.
- ✧ Weight: 2.24 grams

TO-220A

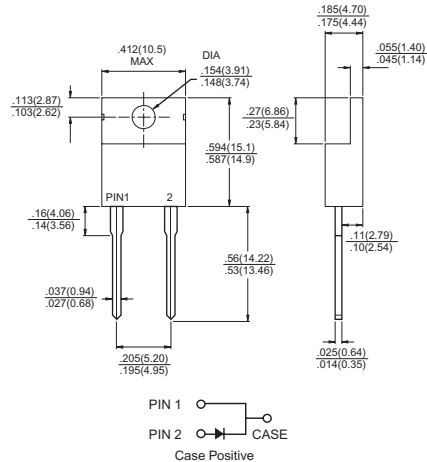

Dimensions in inches and (millimeters)

Maximum Ratings and Electrical Characteristics

Rating at 25°C ambient temperature unless otherwise specified.

Single phase, half wave, 60 Hz, resistive or inductive load.

For capacitive load, derate current by 20%

Type Number	Symbol	SFA 1601G	SFA 1602G	SFA 1603G	SFA 1604G	SFA 1605G	SFA 1606G	SFA 1607G	SFA 1608G	Units
Maximum Recurrent Peak Reverse Voltage	V_{RRM}	50	100	150	200	300	400	500	600	V
Maximum RMS Voltage	V_{RMS}	35	70	105	140	210	280	350	420	V
Maximum DC Blocking Voltage	V_{DC}	50	100	150	200	300	400	500	600	V
Maximum Average Forward Rectified Current @ $T_C = 100^\circ\text{C}$	$I_{(AV)}$	16.0								A
Peak Forward Surge Current, 8.3 ms Single Half Sine-wave Superimposed on Rated Load (JEDEC method)	I_{FSM}	200								A
Maximum Instantaneous Forward Voltage @ 16.0A	V_F	0.975			1.3		1.7			V
Maximum DC Reverse Current @ $T_A=25^\circ\text{C}$ at Rated DC Blocking Voltage @ $T_A=100^\circ\text{C}$	I_R					10				uA
						400				uA
Maximum Reverse Recovery Time (Note 1)	T_{rr}					35				nS
Typical Junction Capacitance (Note 2)	C_j	130				100				pF
Typical Thermal Resistance (Note 3)	$R_{\theta JC}$	1.0								°C/W
Operating Temperature Range	T_J	-65 to +150								°C
Storage Temperature Range	T_{STG}	-65 to +150								°C

Notes: 1. Reverse Recovery Test Conditions: $I_F=0.5A$, $I_R=1.0A$, $I_{RR}=0.25A$

2. Measured at 1 MHz and Applied Reverse Voltage of 4.0 V D.C.

3. Mounted on Heatsink. Size of 3 in x 5 in x 0.25 in Al-Plate.

RATINGS AND CHARACTERISTIC CURVES (SFA1601G THRU SFA1608G)

FIG.1- REVERSE RECOVERY TIME CHARACTERISTIC AND TEST CIRCUIT DIAGRAM

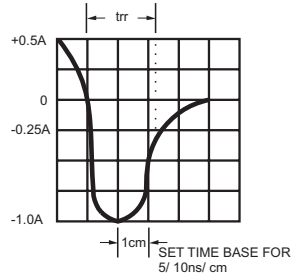
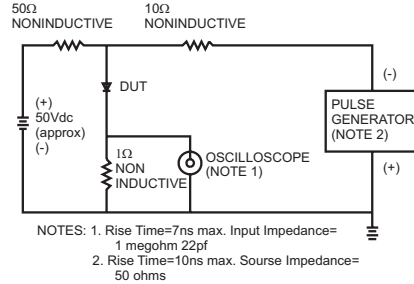

FIG.2- MAXIMUM FORWARD CURRENT DERATING CURVE

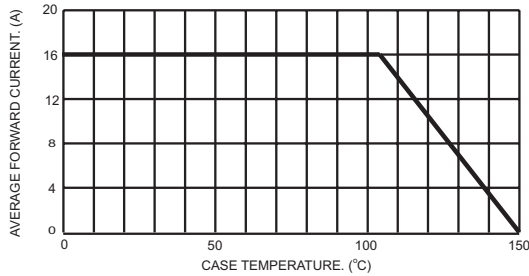

FIG.3- TYPICAL REVERSE CHARACTERISTICS

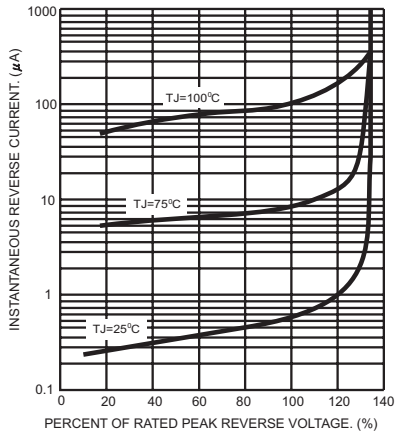

FIG.4- MAXIMUM NON-REPETITIVE FORWARD SURGE CURRENT

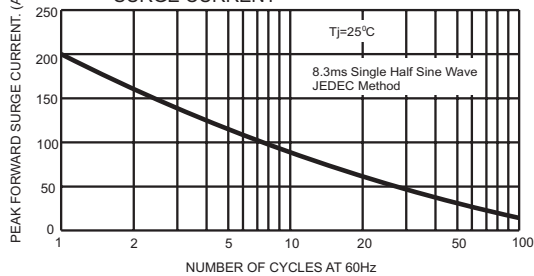

FIG.6- TYPICAL FORWARD CHARACTERISTICS

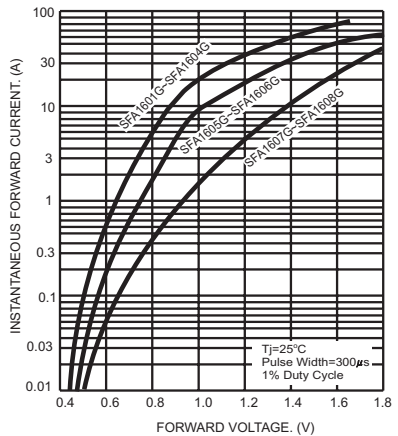

FIG.5- TYPICAL JUNCTION CAPACITANCE

